

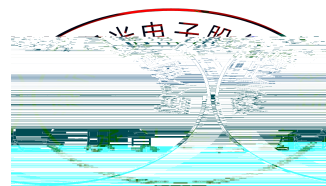

SPECIFICATION



.....	3
General Description	3
.....	3
.....	3
.....	4
.....	5
.....	7
.....	8
.....	11
.....	11

.....	12
.....	13

.....	14
.....	15
.....	15
.....	17
.....	17



1. Description

1.1

1.2 Features

1.3 Application



1.4 Package Dimension

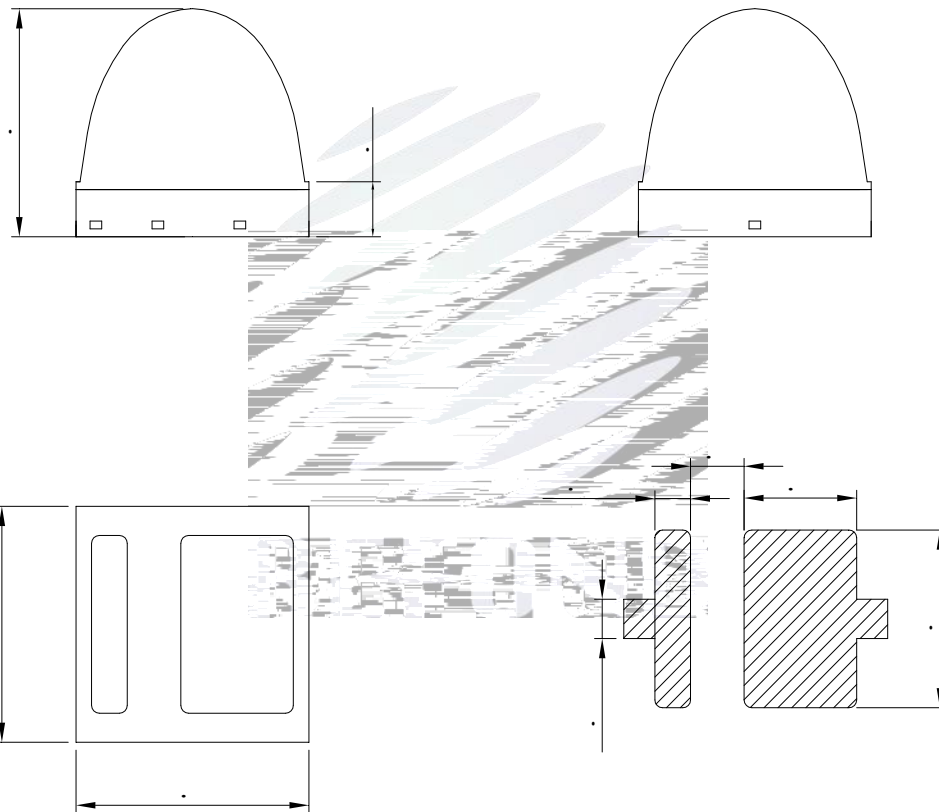
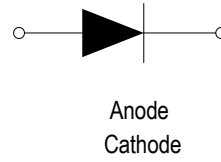
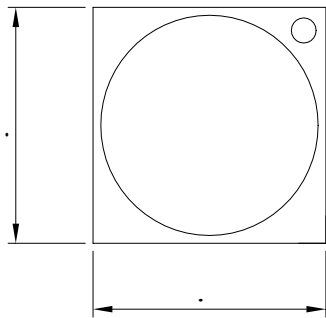

±



REFOND

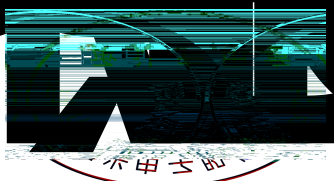

尔甲士的



' u"FO 5P1Y@D@ ;ò €Ñ1è ç
YBROPU@D @)AW5 @X@DY@C@N@S@P@M@Q@P@€ P'±EDP
Q DD XUë U" PH PHW@DÁ U@ ^ D

1.6 Bin Range Of Forward Voltage and Luminous Flux (IF=350mA)

BIN (IF=350mA)

30M

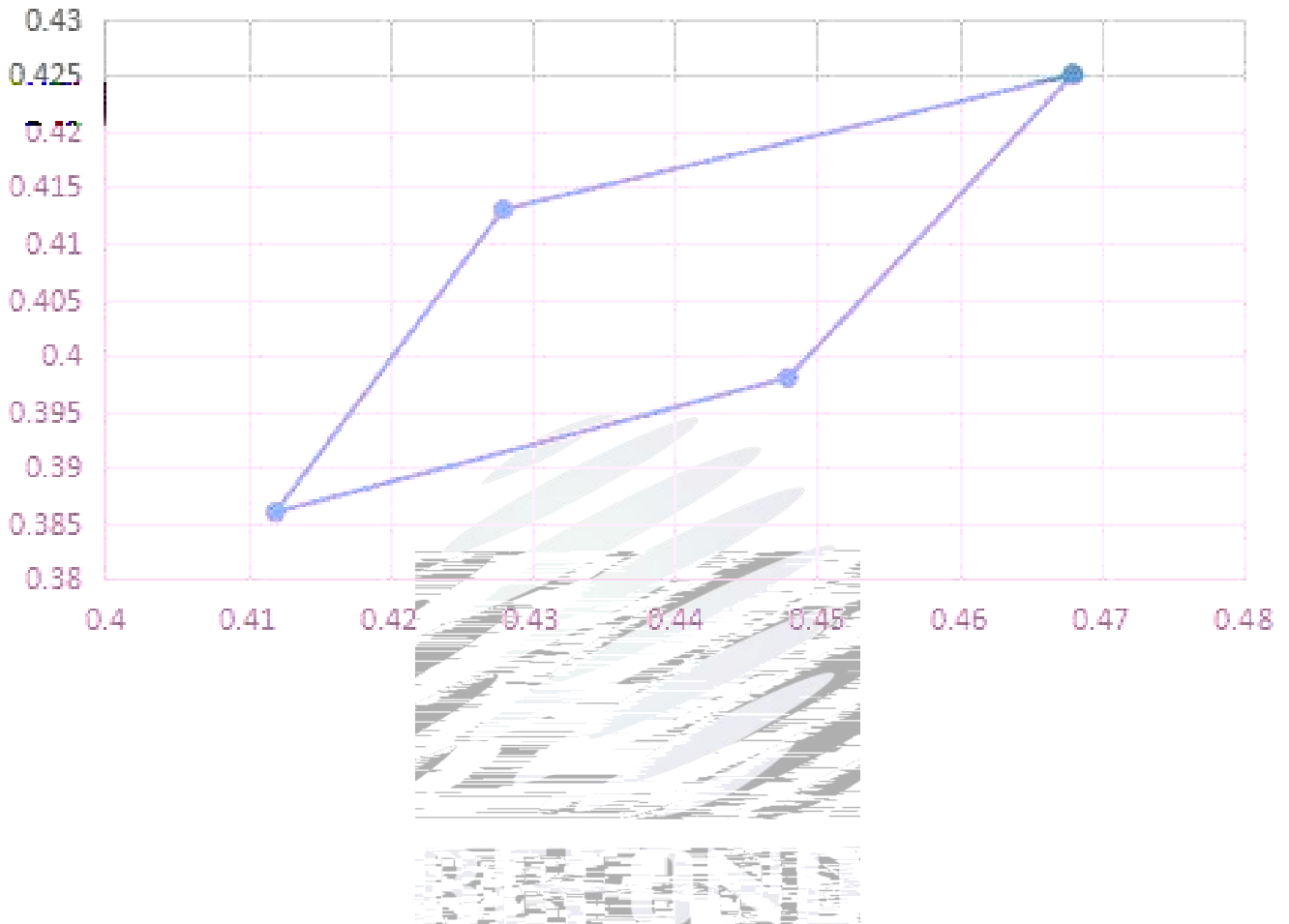

Bin data

Bin Code	X1	Y1	X2	Y2	X3	Y3	X4	Y4
30M	0.468	0.425	0.428	0.413	0.412	0.386	0.448	0.398

1.7 Typical Optical Characteristics Curves

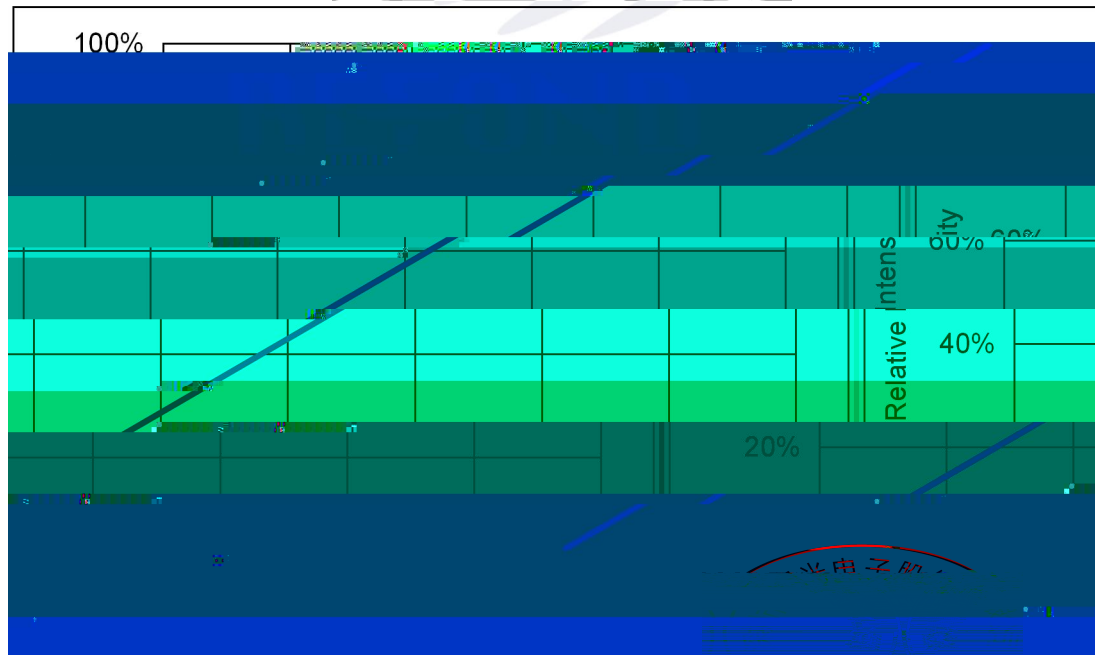
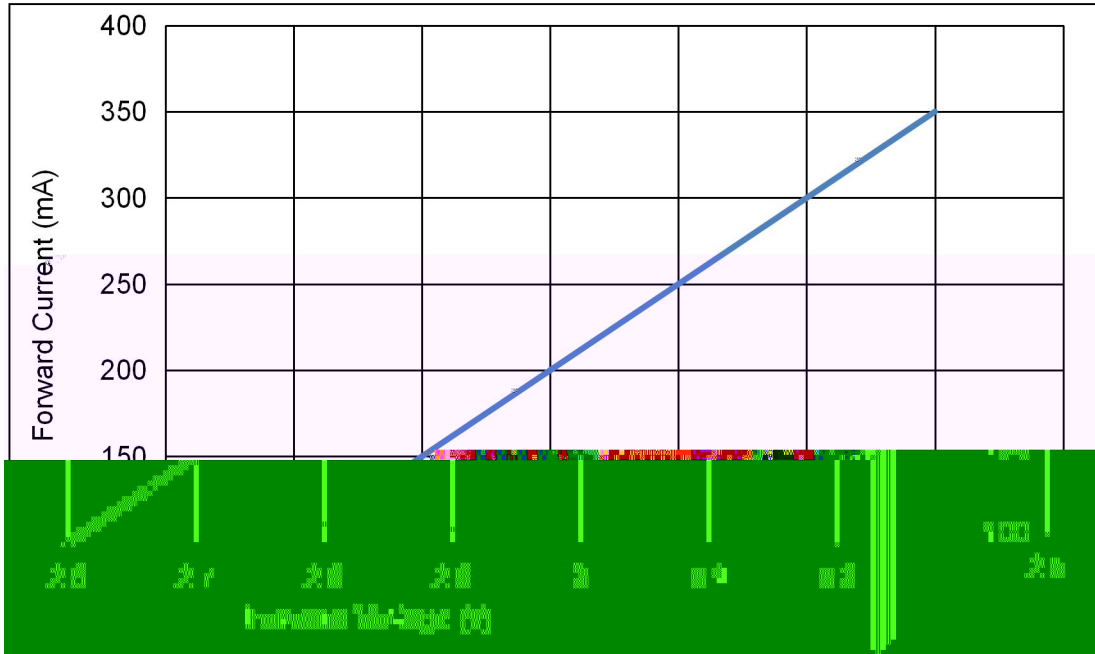

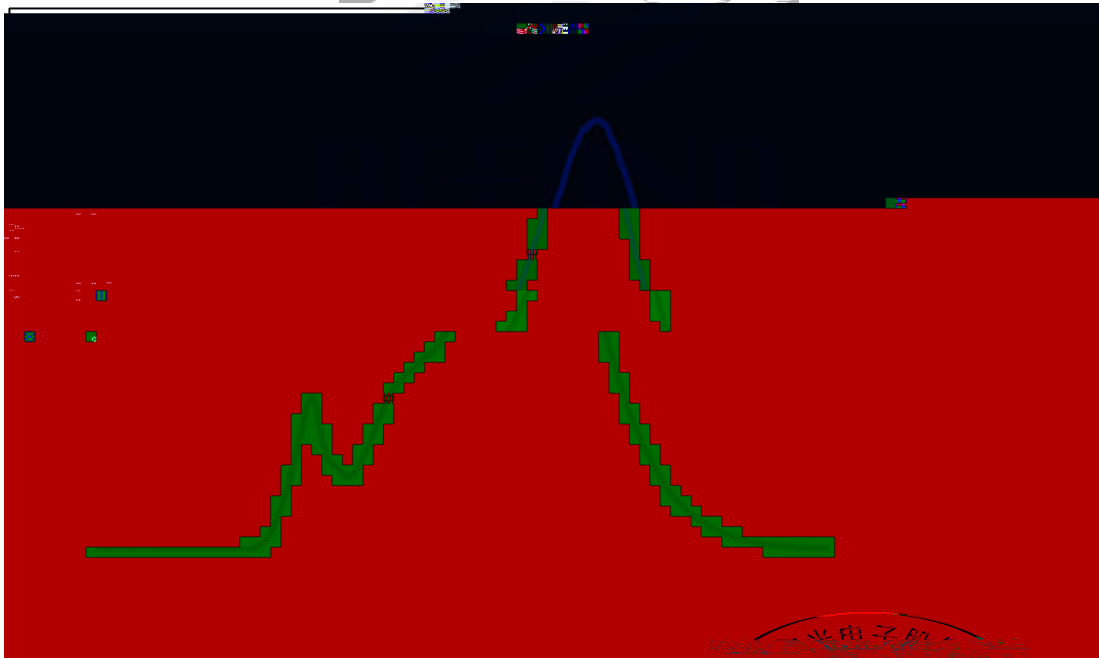
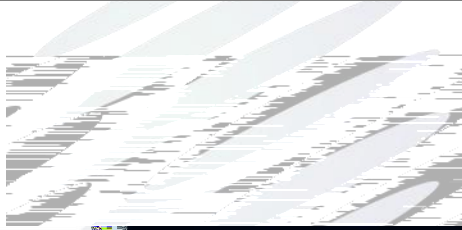
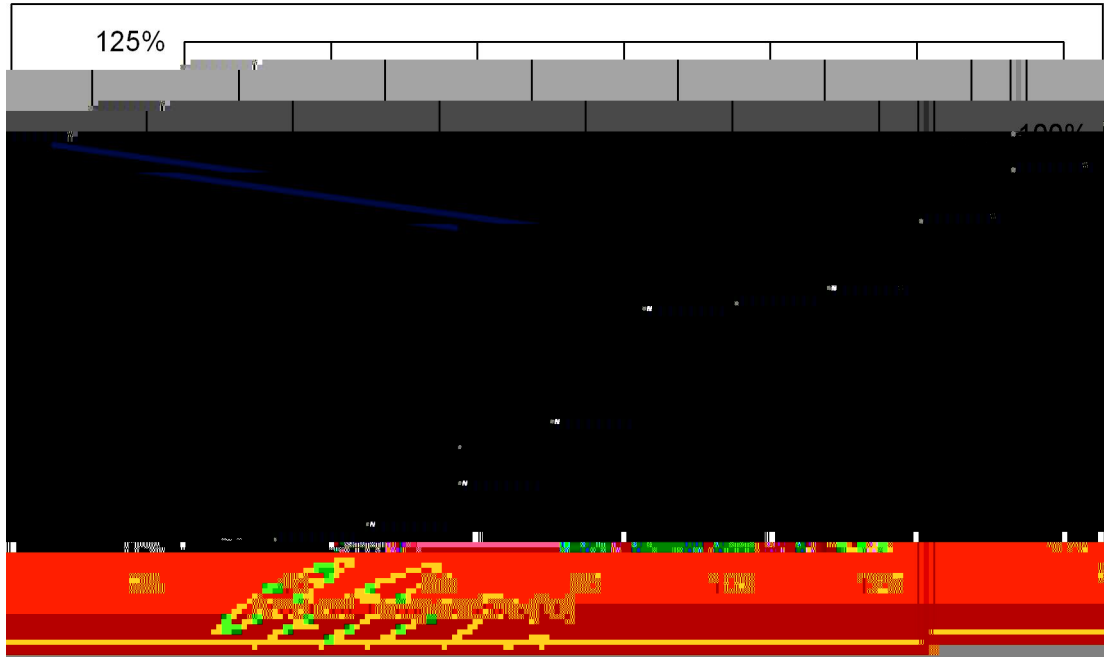

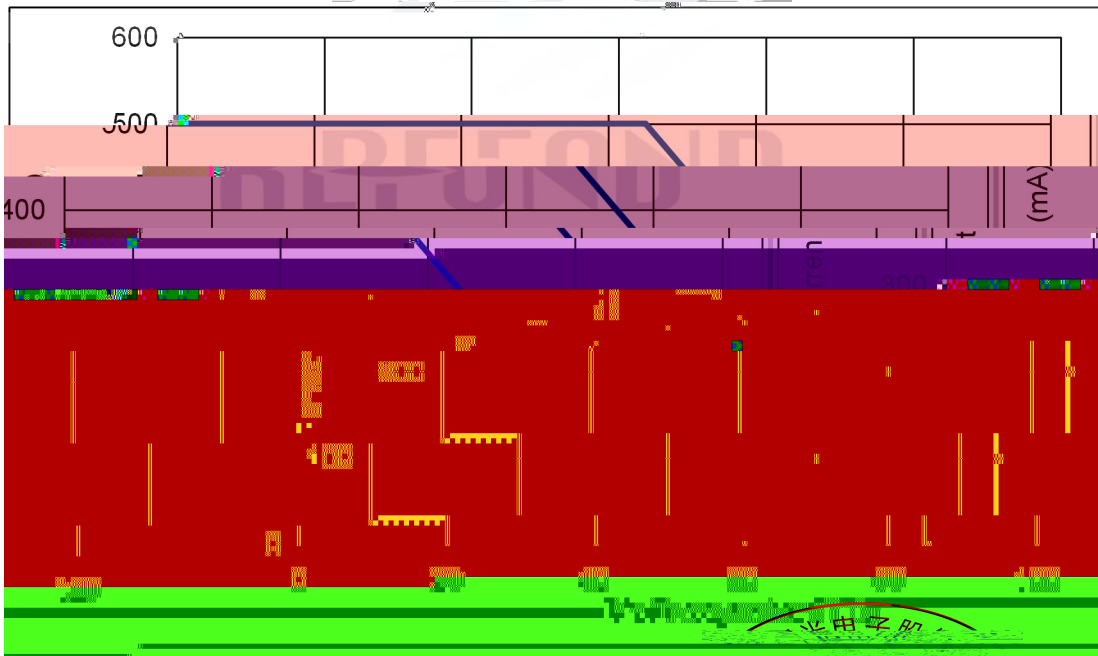
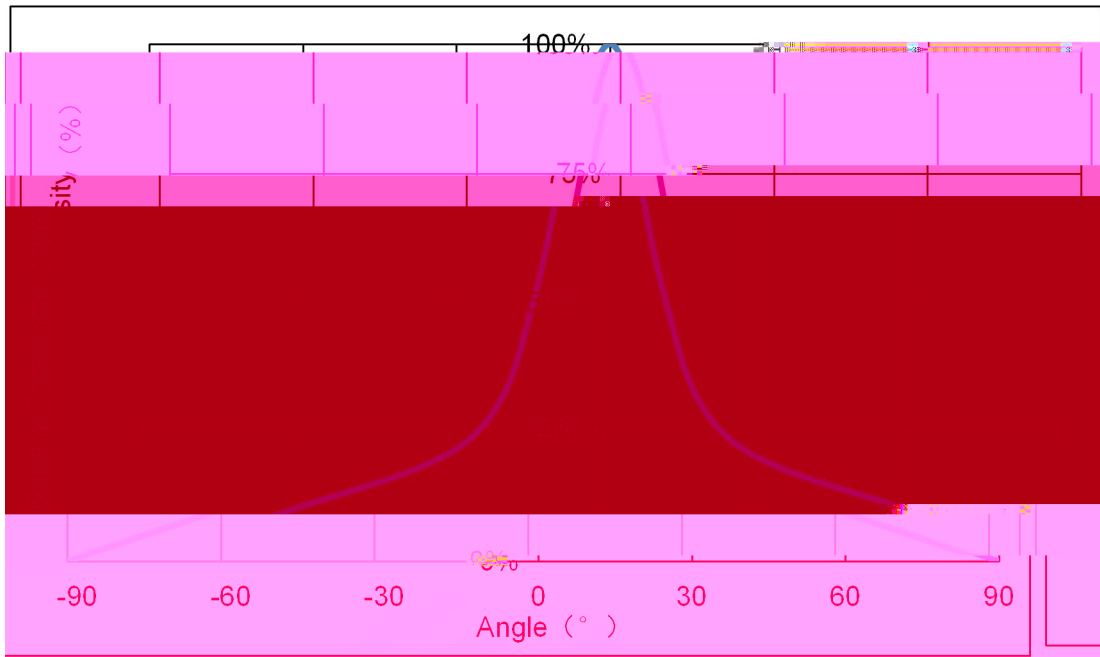

2. Packaging

2.1 Packaging Specification

2500

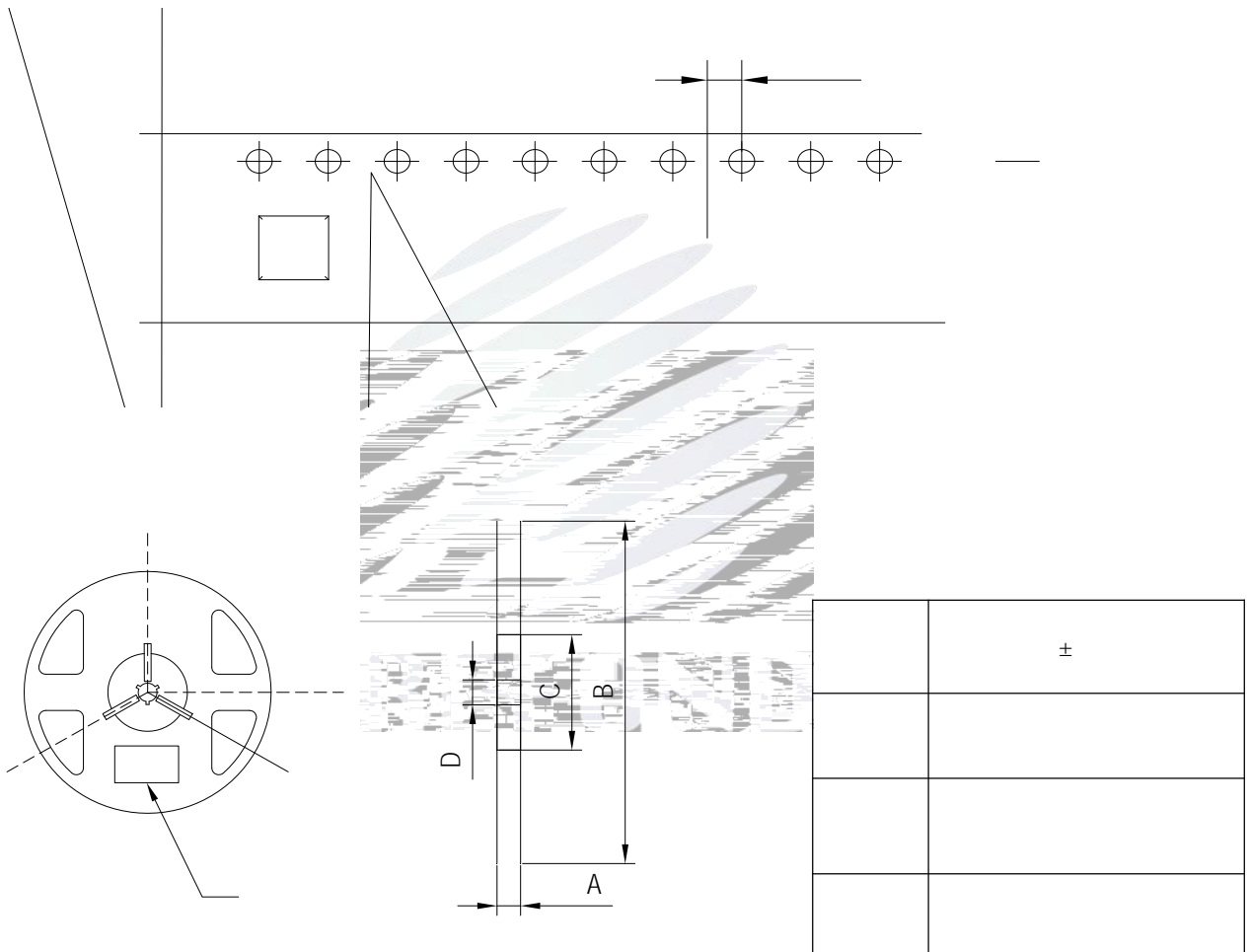

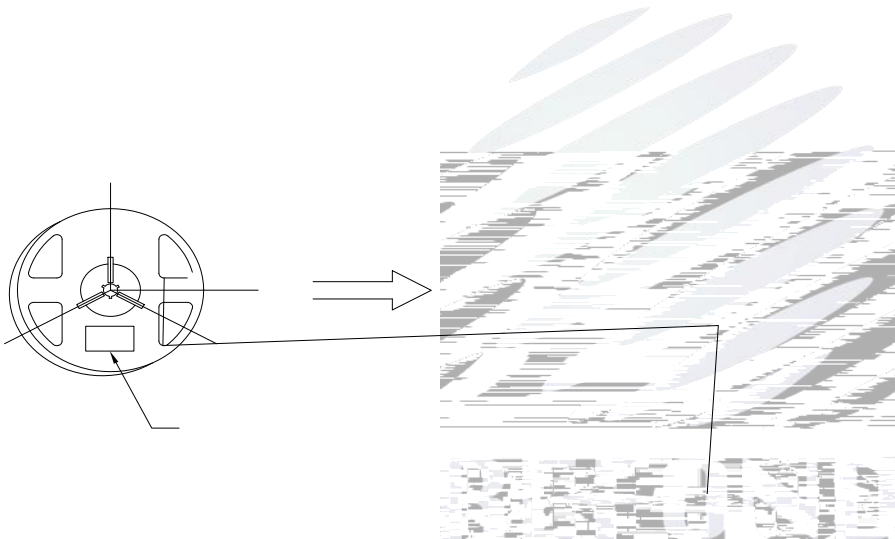

2.5 Criteria For Judging Damage

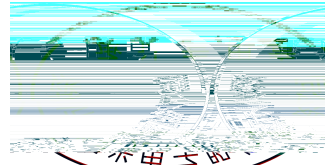

Luminous Flux				



°C

(2)



(1)



4. Handling Precautions

4.1 Handling Precautions

