

C

3

3

3

3

4

5

7

10

10



11

12

13

14

14

16

16

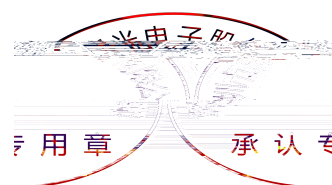

1.1



1.2



1.

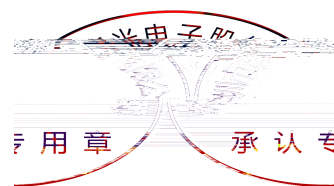

1.

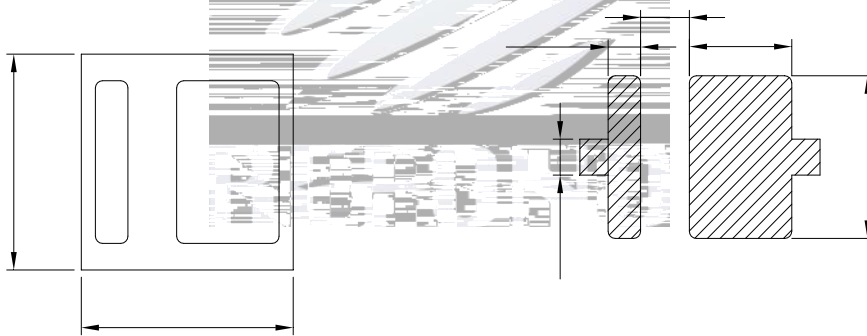
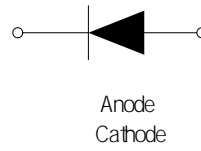
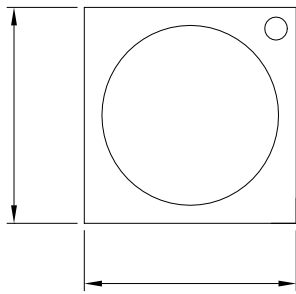

±

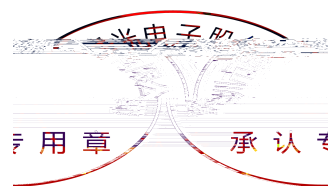

1.

$\lambda$



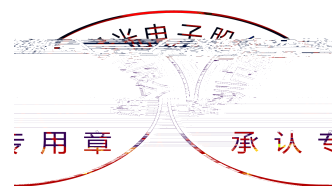

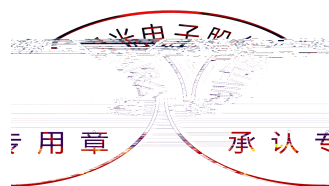

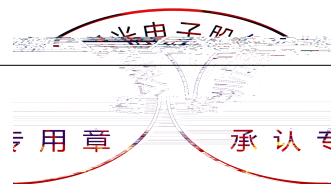
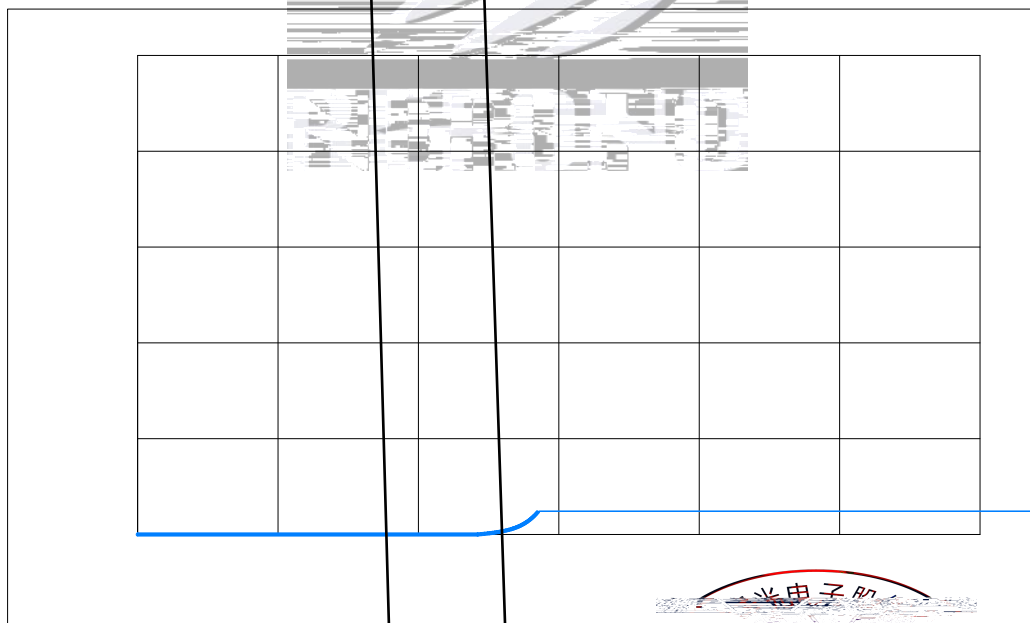
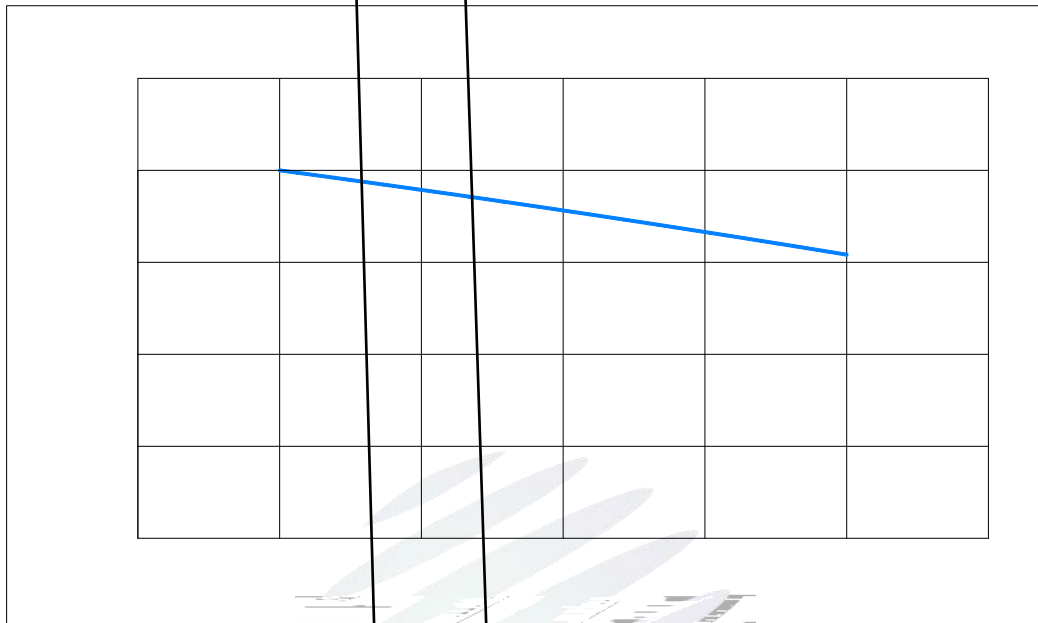

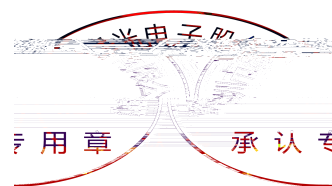
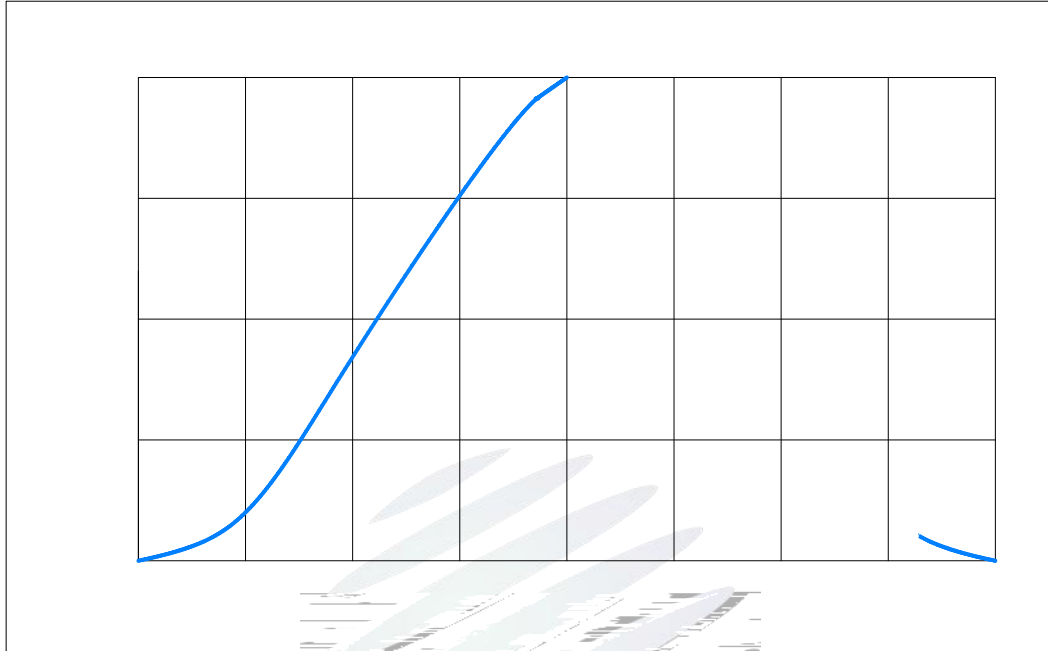

2.1

2.

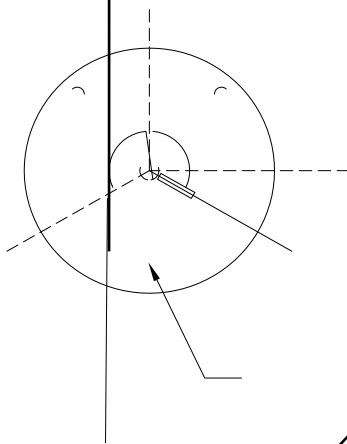
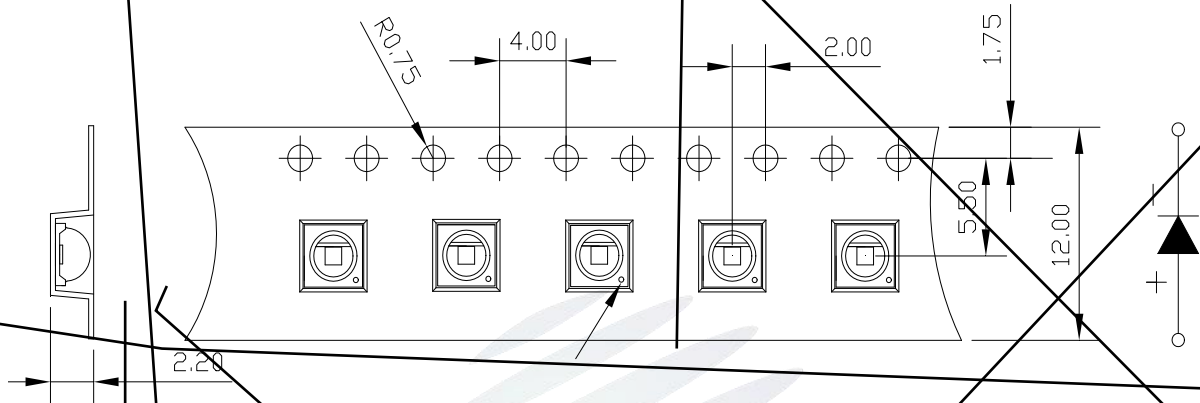

	$\pm$

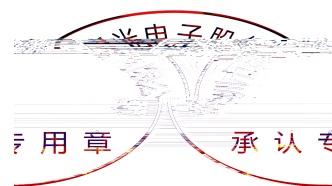

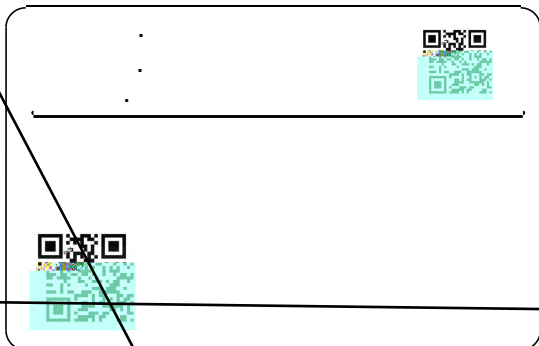

---

---

---

---

---

---

---

---

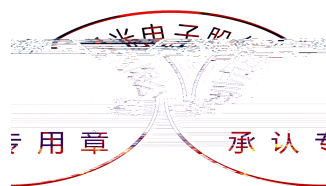
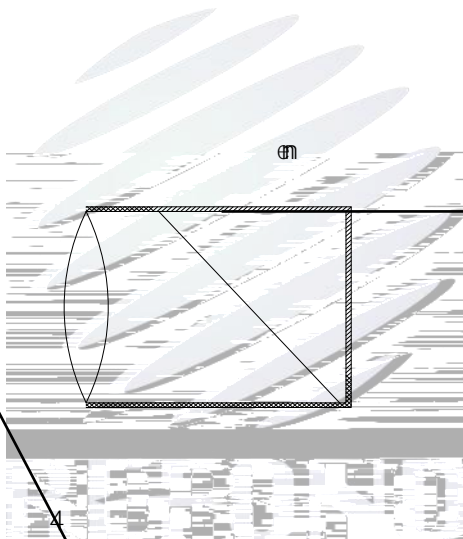
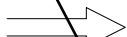
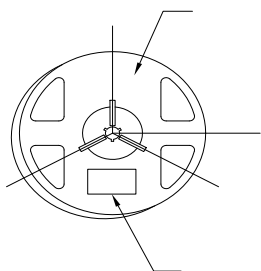

2.

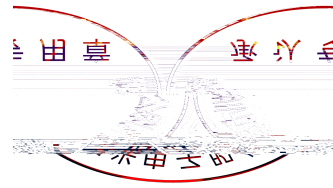

2.

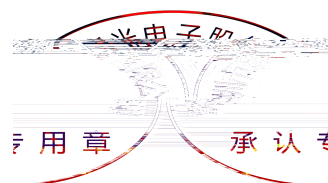

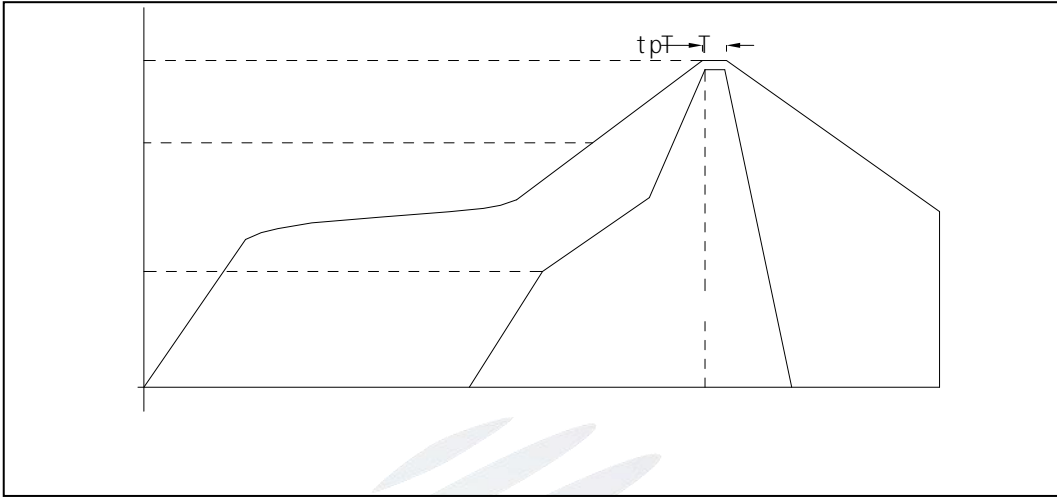

.1

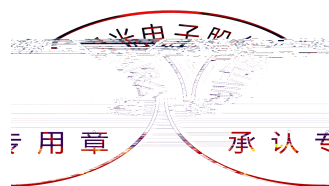

.1

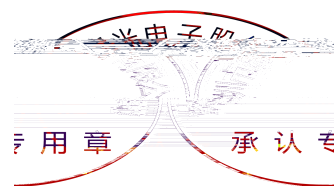



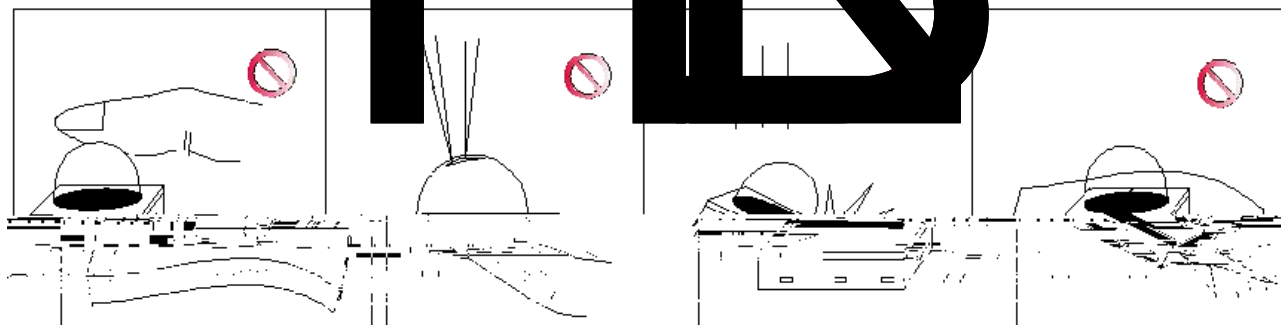
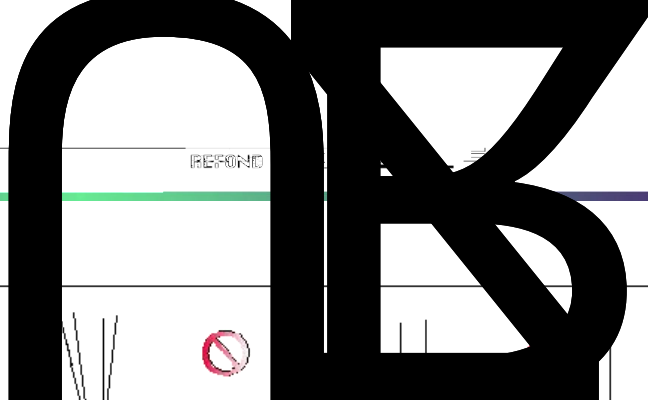

ES0HG

EXPW

E





±

