

SPECIFICATION

REFOND P/N

RF-A4E27-Y92M-S0

R&D

Mass Production



Contents

| | |
|---|-----|
| 1. Description | 3 |
| 1.1 General Description | 3 |
| 1.2 Features | 3 |
| 1.3 Application | 3 |
| 1.4 Package Dimension | 4 |
| 1.6 Bin Range Of Forward Voltage and Luminous Flux (IF=700mA) | BIN |
| (IF=700mA) | 6 |
| 1.7 Typical Optical Characteristics Curves | 7 |
| 2. Packaging | 11 |
| 2.1 Packaging Specification | 11 |
| 2.1.1 Carrier Tape Dimension | 11 |
| 2.1.2 Reel Dimension | 11 |
| 2.1.3 Label Form Specification | 12 |
| 2.2 Moisture Resistant Packing | 12 |
| 2.3 Cardboard Box | 12 |
| 2.4 Reliability Test Items And Conditions | 13 |
| 2.5 Criteria For Judging Damage | 14 |
| 3. SMT Reflow Soldering Instructions SMT | 15 |
| 3.1 SMT Reflow Soldering Instructions SMT | 15 |
| 4. Handling Precautions | 17 |
| 4.1 Handling Precautions | 17 |



1. Description

1.1

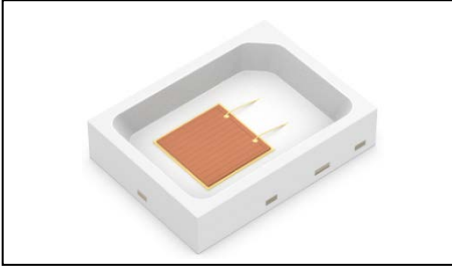

The Yellow source color devices are made with AlGaInp on Substrate Light Emitting Diode .

Product Package:2.7mmX2.0mmX0.6mm.

LED AlGaInp

2.7mmX2.0mmX0.6mm.

1.2 Features

PLCC Package.PLCC

Extremely wide viewing angle.

Suitable for all SMT assembly and solder process.

SMT

Available on tape and reel.

Moisture sensitivity level: Level 2.

Level2

RoHS compliant. RoHS

Qualifications: The product qualification test plan is based on the guidelines of AEC-Q102 Stress Test Qualification for Automotive Grade Discrete Semiconductors

AEC-Q102

1.3 Application

Automotive Lighting Interior and Exterior.



1.4 Package Dimension

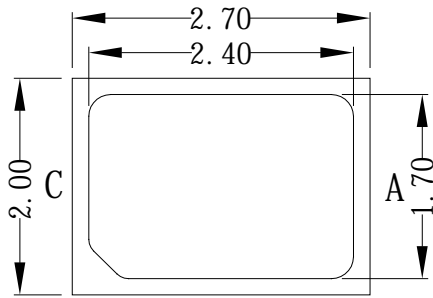

Fig.1-1 Top View

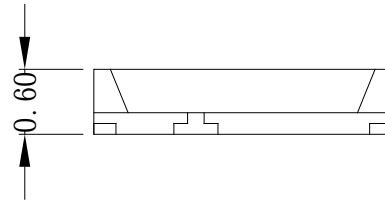

Fig.1-2 Side View

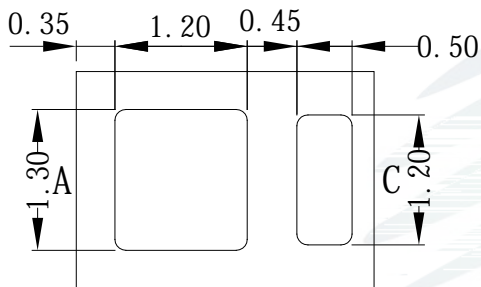

Fig.1-3 Bottom View

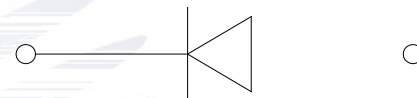

Fig.1-4 Polarity

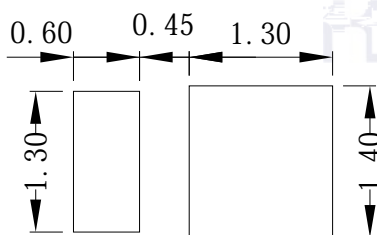

Fig.1-5 Soldering Patterns

Notes

1. All dimensions units are millimeters.
2. All dimensions tolerances are $\pm 0.05\text{mm}$ unless otherwise noted.

± 0.05

1.5 Product Parameters

Table 1-1 Electrical / Optical Characteristics at Ts=25°C

| Item | Symbol | Test Condition | Value | | | Unit |
|---------------------|-------------|--------------------|-------|------|------|-----------------------------|
| | | | Min. | Typ. | Max. | |
| Forward Voltage | V_F | $I_F=700\text{mA}$ | 2.2 | --- | 2.8 | V |
| Reverse Current | I_R | $V_R=5\text{V}$ | --- | --- | 10 | μA |
| Dominant Wavelength | λ_D | $I_F=700\text{mA}$ | 587.5 | --- | 595 | nm |
| Luminous Flux | | $I_F=700\text{mA}$ | 83.7 | --- | 130 | lm |
| Viewing Angle | | $I_F=700\text{mA}$ | --- | 120 | --- | deg |
| Thermal Resistance. | R_{THJ-S} | $I_F=700\text{mA}$ | --- | --- | 16 | $^{\circ}\text{C}/\text{W}$ |

Table 1-2 Absolute Maximum Ratings at Ts=25°C

| Parameter | Symbol | Rating | Units |
|-------------------------------|-----------|------------|-------|
| Power Dissipation | P_D | 1820 | mW |
| Forward Current | I_F | 700 | mA |
| Peak Forward Current | I_{FP} | 1000 | mA |
| Reverse Voltage | V_R | 5 | V |
| Electrostatic Discharge (HBM) | E_{SD} | 2000 | V |
| Operating Temperature | T_{OPR} | -40 ~ +125 | |
| Storage Temperature | T_{STG} | -40 ~ +125 | |
| Junction Temperature | T_J | 150 | |

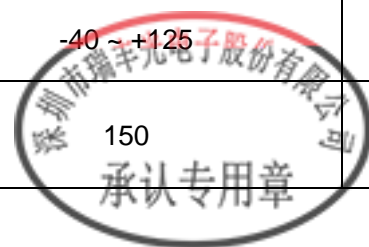

Notes



F

Tel: +86-755-29675000
REFOND:WI-

E-mail:sales@refond.com

Web: www.refond.com

PAGE:7

丰富人类生活 创新科技
novation enrich life 创新科技 Inr

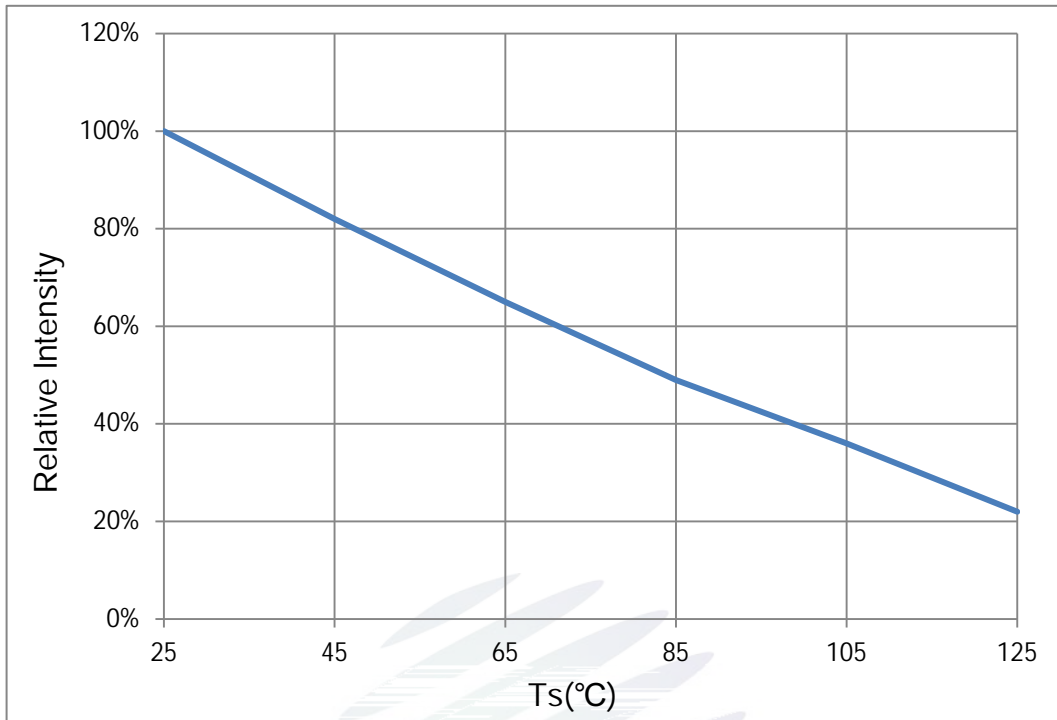

Fig. 1-9 Solder Temperature Vs Relative Intensity

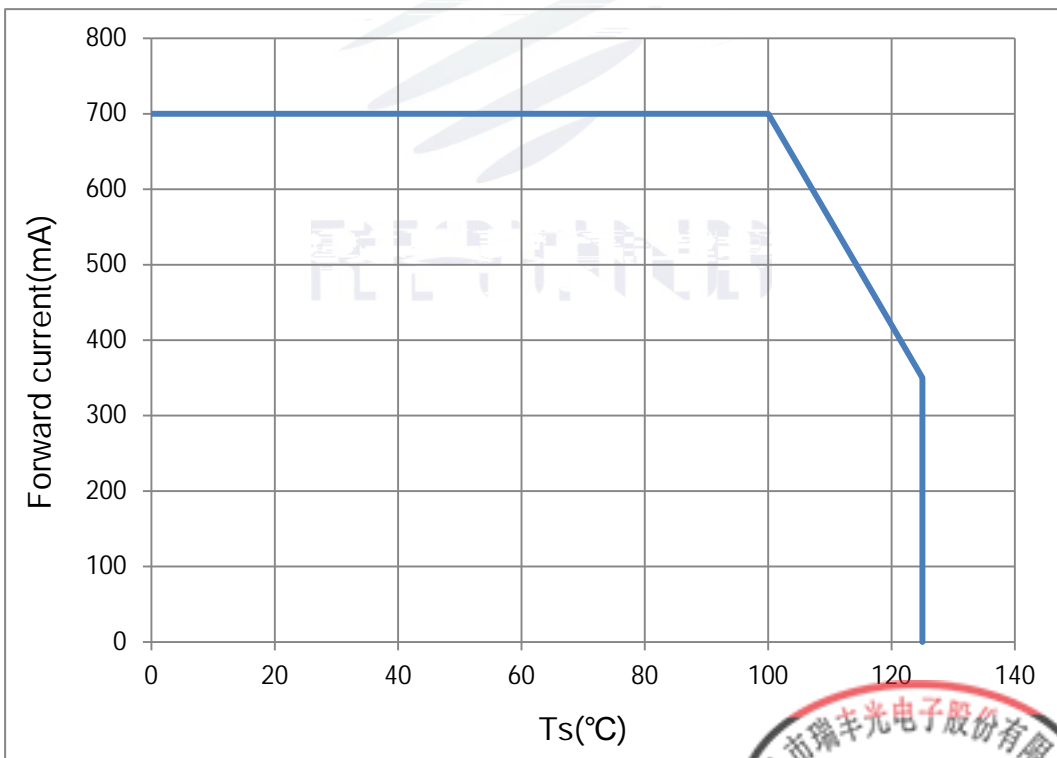

Fig. 1-10 Solder Temperature Vs Forward Current



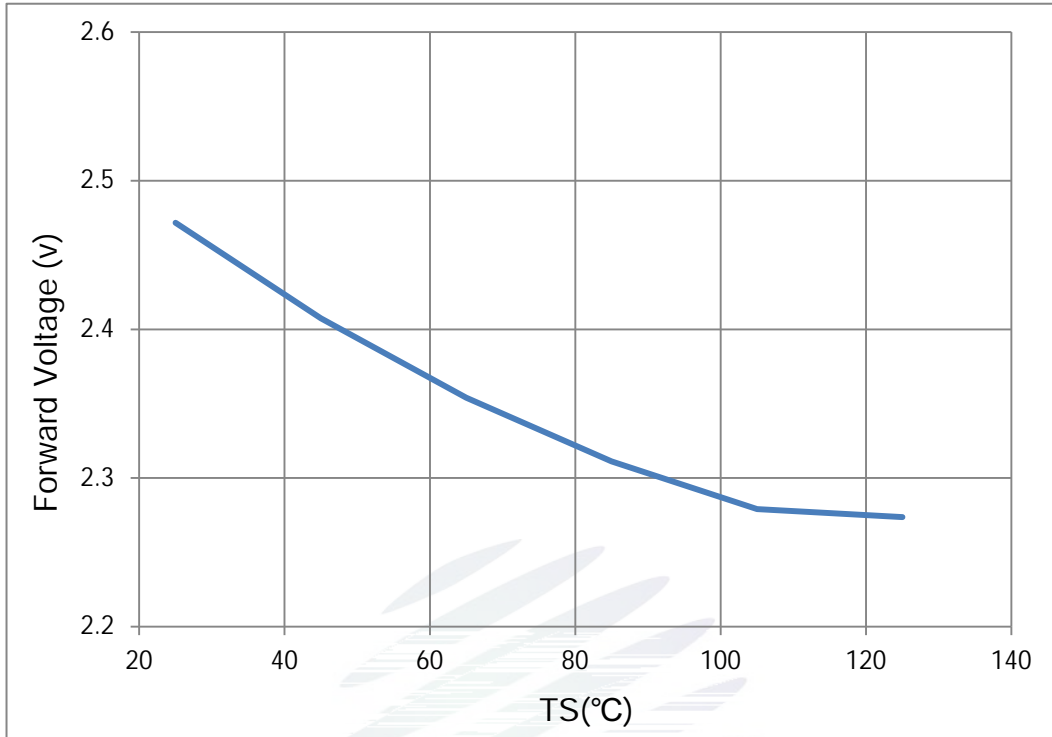

Fig. 1-11 Forward Voltage Vs Solder Temperature

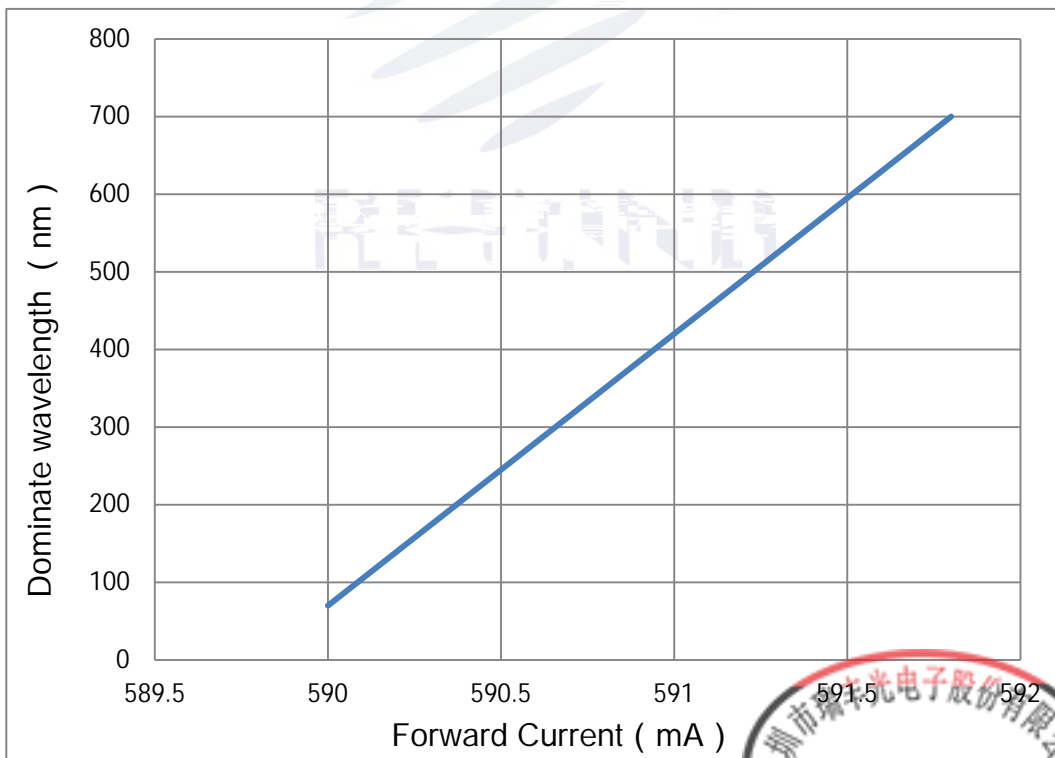
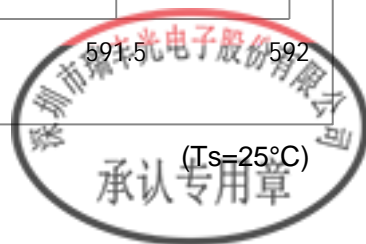

Fig. 1-12 Forward current vs. Color Shift



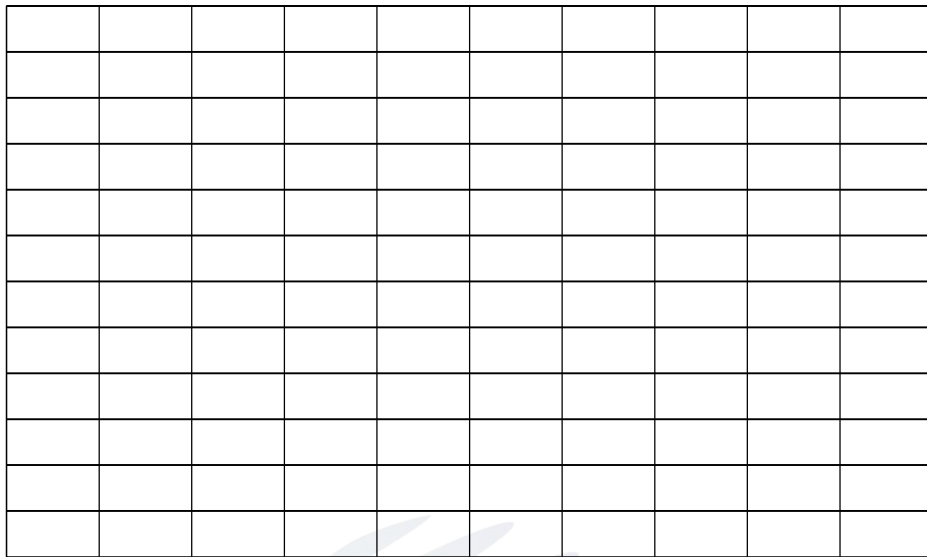

Fig. 1-13 Radiation diagram

Fig. 1-14 Spectrum Distribution

2. Packaging

2.1 Packaging Specification

Package:4000pcs/reel. 4000pcs

2.1.1 Carrier Tape Dimension

C.8 re W n BT8 0 Td [<9CBF>-5<43043Fn

Fig.2-



2.1.3 Label Form Specification

Table 2-2 Specification

| | |
|----------|------------------|
| PART NO. | Part Number |
| SPEC NO. | Spec Number |
| LOT NO. | Lot Number |
| BIN CODE | Bin Code |
| | Luminous flux |
| XY | Chromaticity Bin |
| V_F | Forward Voltage |
| WLD | Wavelength |
| QTY | Packing Quantity |
| DATE | Made Date |

Fig. 2-3 Label

2.2 Moisture Resistant Packing

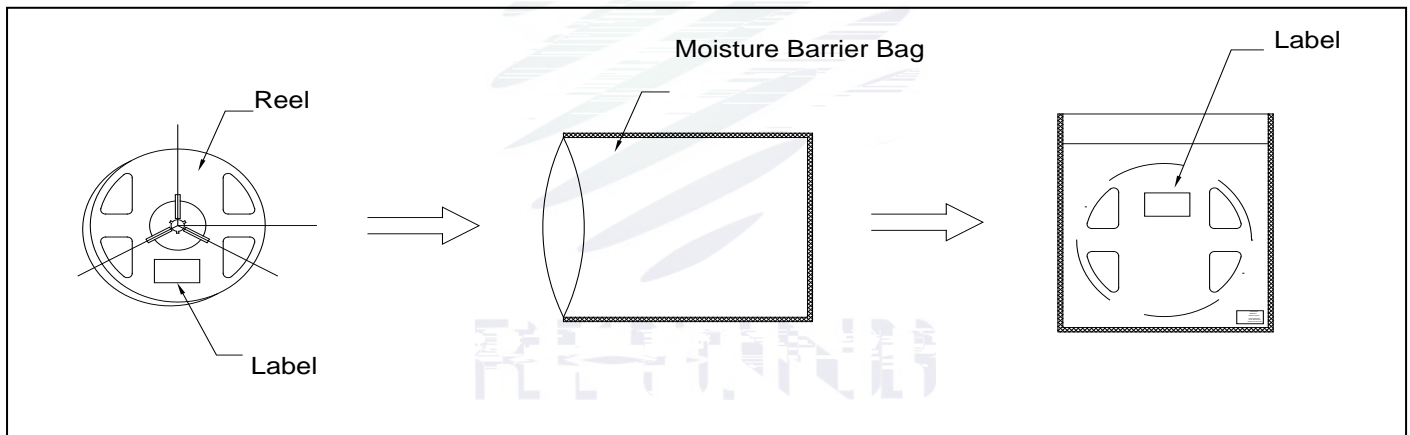

Fig.2-4Moisture Resistant Packing

2.3 Cardboard Box

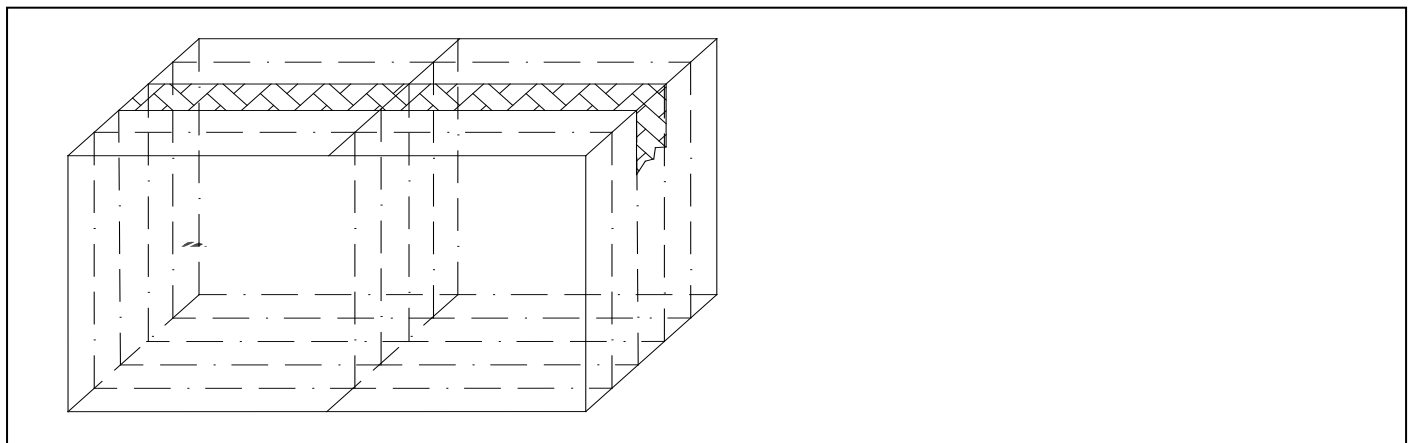

Fig.2-5Cardboard Box

2.4 Reliability Test Items And Conditions

Table 2-3 Reliability Test Items And Conditions

| Test Items | Ref.Standard | Test Condition | Time | Quantity | Ac/Re / |
|---|------------------------|-------------------------------|------------|----------|------------|
| Reflow | JESD22-B106 | Temp:260 max T=10 sec | 2times | 20pcs. | 0/1 |
| MSL2 2 | JESD22-A113 | 85 / 60%RH | 168 hrs. | 20pcs. | 0/1 |
| Thermal Shock | JEITAED-4701 300307 | -40 15min 10s 125 15min | 1000 cycle | 20pcs. | 0/1 |
| Life Test | JESD22-A108 | Ta=105 If=700mA | 1000hrs. | 20pcs. | 0/1 |
| High Temperature High Humidity Life Test | JESD22-A101 | 85 / 85%RH If=700mA | 1000hrs. | 20pcs. | 0/1 |



2.5 Criteria For Judging Damage

Table 2-4 Criteria For Judging Damage

| Test Items | Symbol | Test Condition | Criteria For Judgement | |
|-----------------|--------|--------------------|------------------------|-------------|
| | | | Min. | Max. |
| Forward Voltage | V_F | $I_F=700\text{mA}$ | - | U.S.L*)x1.1 |
| Reverse Current | I_R | $V_R = 5V$ | - | U.S.L*)x2.0 |
| Luminous Flux | | $I_F=700\text{mA}$ | L.S.L*)x0.7 | - |

Notes

- 1.U.S.L: Upper standard level L.S.L: Lower standard level
- 2.The above reliability tests is based on the verification of a single/strip LED of Refond's existing experimental platform,the reliability experiment was taken under good heat dissipation conditions. when customers applies the LED to the series and parallel circuit, should take consideration of all the factors such as the current, voltage distribution, heat dissipation and others. / LED
LED
- 3.The technical information shown in the data sheets is limited to the typical characteristics and circuit examples of the referenced products. It does not constitute the warranting of industrial property nor the granting of any license.



3. SMT Reflow Soldering Instructions SMT 回流焊说明

3.1 SMT Reflow Soldering Instructions SMT

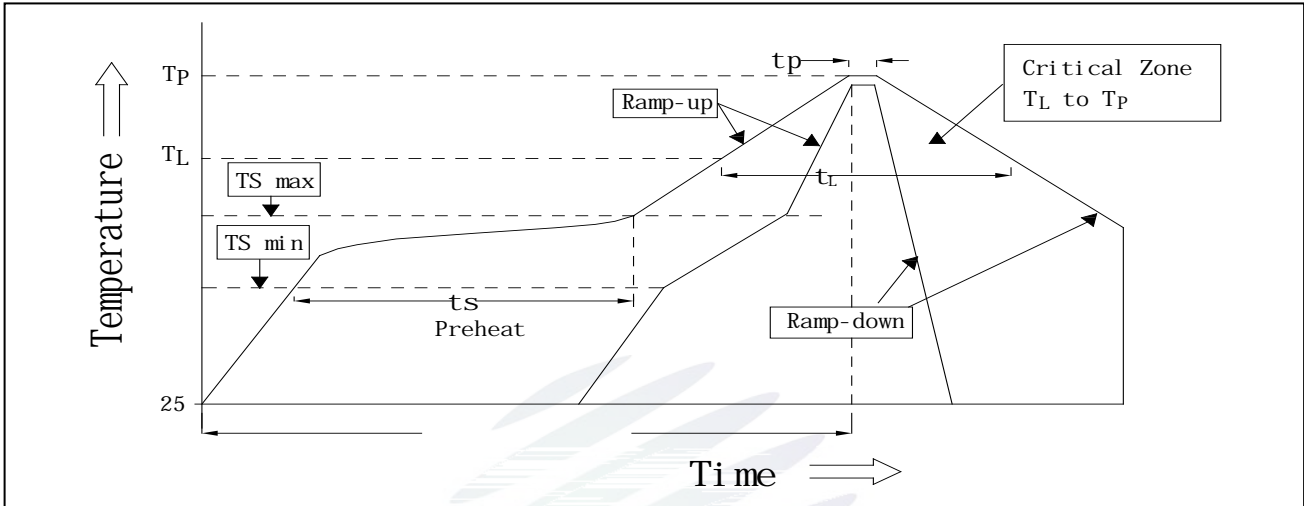
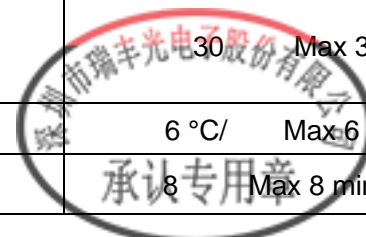

Fig.3-1 SMT Reflow Soldering Instructions SMT

Table 3-1 Reflow parameters

| | | |
|---|-------------------------------------|-------------------|
| Average temperature rise speed | T _{smax} T _P | 3 °C/ Max 3 °C/ s |
| Preheating: minimum temperature | (T _{smin}) | 150 °C |
| Preheating: Max temperature | (T _{smax}) | 200 °C |
| Preheating: Time | T _{smin} T _{smax} | 60 - 120 60s-120s |
| Time limited to maintain high temperature: the temperature | (T _L) | 217 °C |
| Time limited to maintain high temperature: The Time | (t _L) | 60 Max 60s |
| Peak /Classification of temperature: | / (T _P) | 260 °C |
| Time limit classification of peak temperature time | t _p | 10 Max 10s |
| Hold time within 5°C with the actual peak temperature (T _P) | (T _P) 5°C | 30 Max 30s |
| Cooling speed | | 6 °C/ Max 6 °C/ s |
| Needed time from 25 °C to T _P | 25°C | 8 Max 8 minutes |



Notes

(1)Reflow soldering should not be done more than twice. If more than 24 hours between the two solderings , LED will be damaged. 24 LED

(2)Whensoldering, do not put stress on the LEDs during heating.

3.1.1 Repairing

Repairing should not be done after the LEDs have been soldered. When repairing is unavoidable,a double-head soldering iron should be used (as below figure). It should be confirmed in advance whether the characteristics of LEDs will or not be damaged by repairing.

LED

LED

3.1.2 Cautions

(1) The encapsulated material of the LEDs is silicone. Therefore the LEDs have a soft surface on the top of package. The pressure to the top surface will be impacted on the reliability of the LEDs. Precautions should be taken to avoid the strong pressure on the encapsulated part. So when use the picking up nozzle, the pressure on the silicone resin should be proper. LED LED

(2) Components should not be mounted on warped (non coplanar) portion of PCB. After soldering, do not warp the circuit board.LED PCB

(3) Do not apply mechanical force or excess vibration during the cooling process to normal temperature after soldering. Do not rapidly cool device after soldering.



4. Handling Precautions

4.1 Handling Precautions

(1) LED operating environment and sulfur element composition cannot be over 100PPM in the LED mating usage material. This is provided for informational purposes only and is not a warranty or endorsement.

LED 100PPM

(2) In order to prevent external material from getting into the inside of LED, which may cause the malfunction of LED, the single content of Bromine element is required to be less than 900PPM, the single content of Chlorine element is required to be less than 900PPM, the total content of Bromine element and Chlorine element in the external materials of the application products is required to be less than 1500PPM. This is provided for informational purposes only and is not a warranty or endorsement.

| | | |
|---------|--------|--------|
| | LED | LED |
| | 900PPM | 900PPM |
| 1500PPM | | |

(3) VOCs (Volatile organic compounds) emitted from materials used in the construction of fixtures can penetrate silicone encapsulants of LEDs and discolor when exposed to heat and photonic energy. The result can be a significant loss of light output from the fixture. Knowledge of the properties of the materials selected to be used in the construction of fixtures can help prevent these issues. Refond advises against the use of any chemicals or materials that have been found or are suspected to have an adverse effect on device performance or reliability. To verify compatibility, Refond recommends that all chemicals and materials be tested in the specific application and environment for which they are intended to be used. Attaching LEDs, do not use adhesives that outgas organic vapor.

LED LED

LED

(4) Handle the component along the side surface by using forceps or appropriate tools. Do not directly touch or handle the silicone lens surface, it may damage the internal circuitry.



Fig 4-1 Handling Precautions

(5) In designing a circuit, the current through each LED can not exceed the absolute maximum rating specified for each LED. In the meanwhile, resistors for protection should be applied, otherwise slight voltage shift will cause big current change, burn out may happen. The driving circuit must be designed to allow forward voltage only when it is ON or OFF. If the reverse voltage is applied to LED, migration can be generated resulting in LED damage.

LED

LED

(6) Thermal Design is paramount importance because heat generation may result in the Characteristics decline, such as brightness decreased, Color change and so on. Please consider the heat generation of the LEDs when making the system design.

LED

LED

(7) Compared to standard encapsulants, silicone is generally softer, and the surface is more likely to attract dust, requiring special care during processing. In cases where a minimal level of dirt and dust particles cannot be guaranteed, a suitable cleaning solution must be applied to the surface after the soldering of components. Refond suggests using isopropyl alcohol for cleaning. In case other solvents are used, it must be assured that these solvents do not dissolve the package or resin. Ultrasonic cleaning is not recommended. Ultrasonic cleaning may cause damage to the LED.

LED



Declare

This specification is written both in English and in Chinese and the latter is formal.