

1.

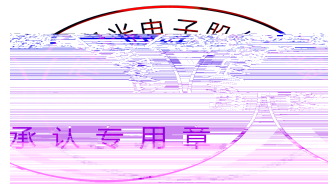

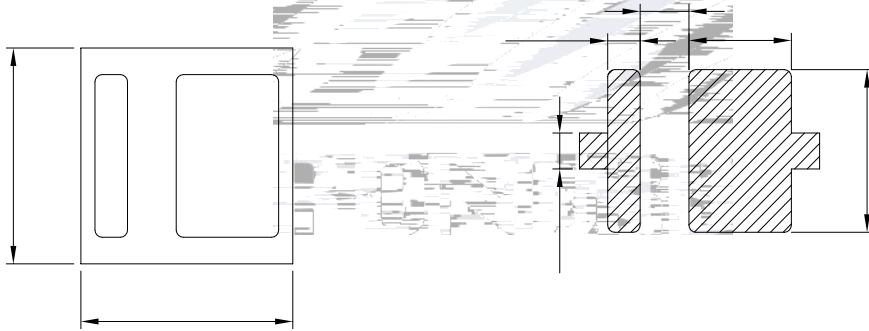

±

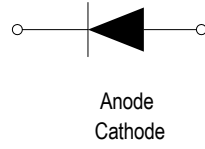
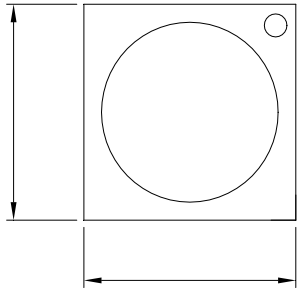
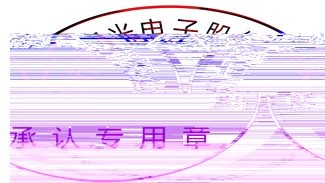

	λ					

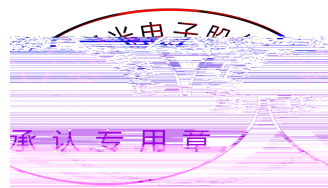
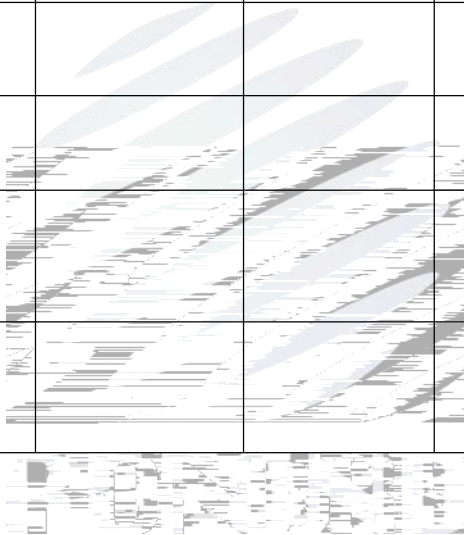



瑞豐光電



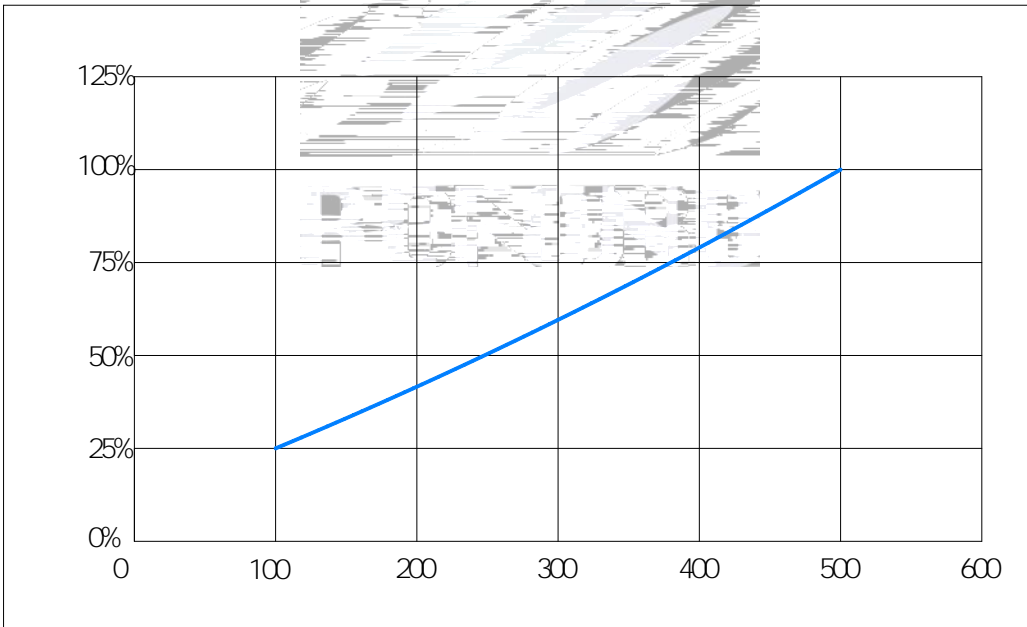
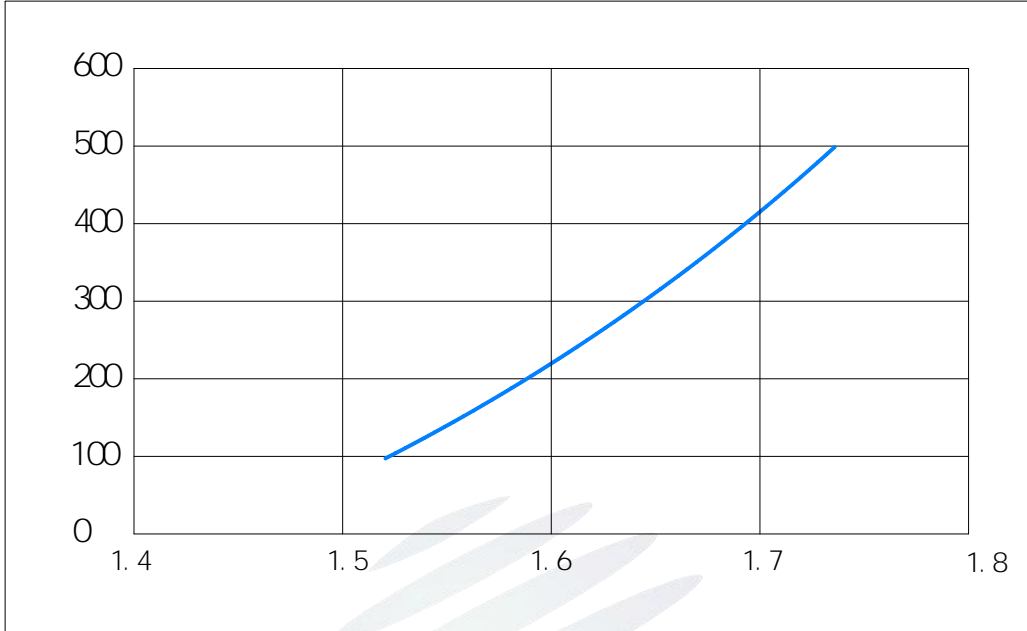

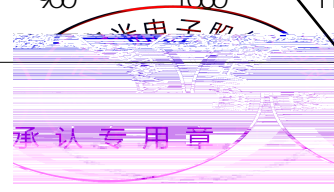
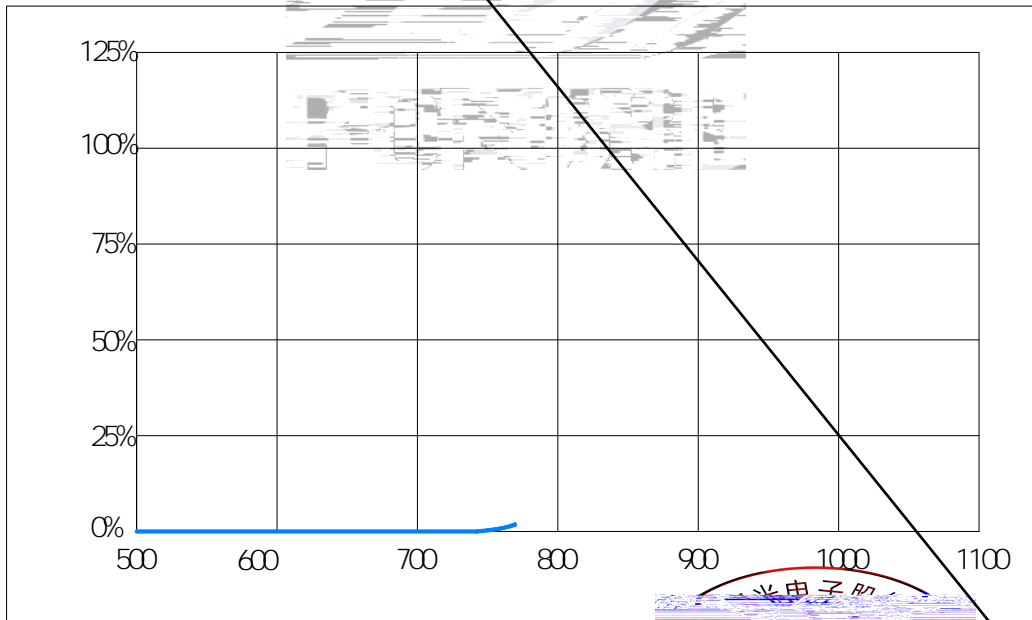
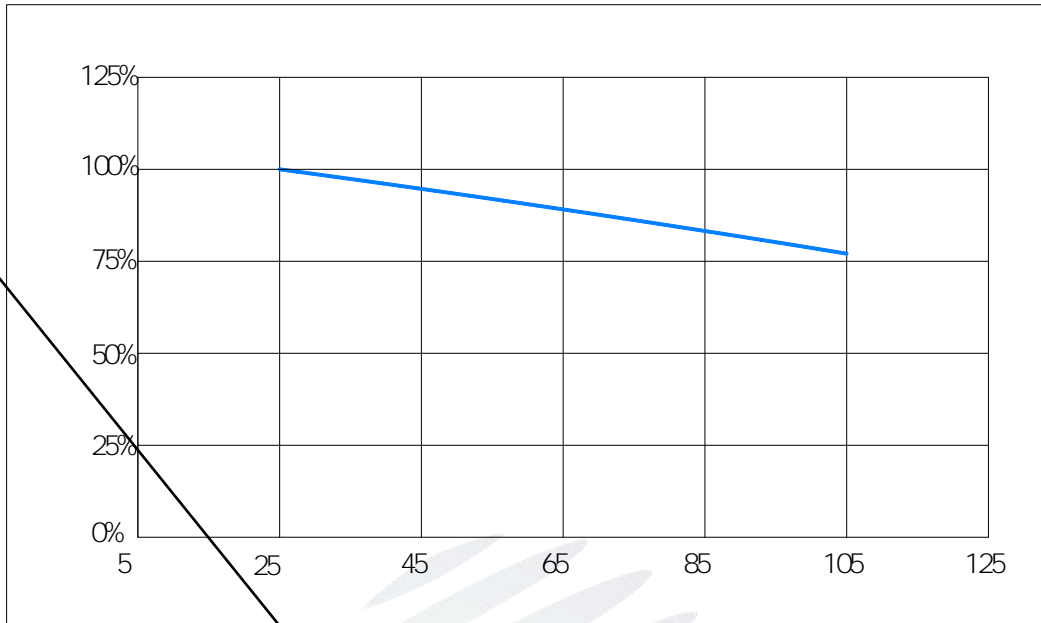

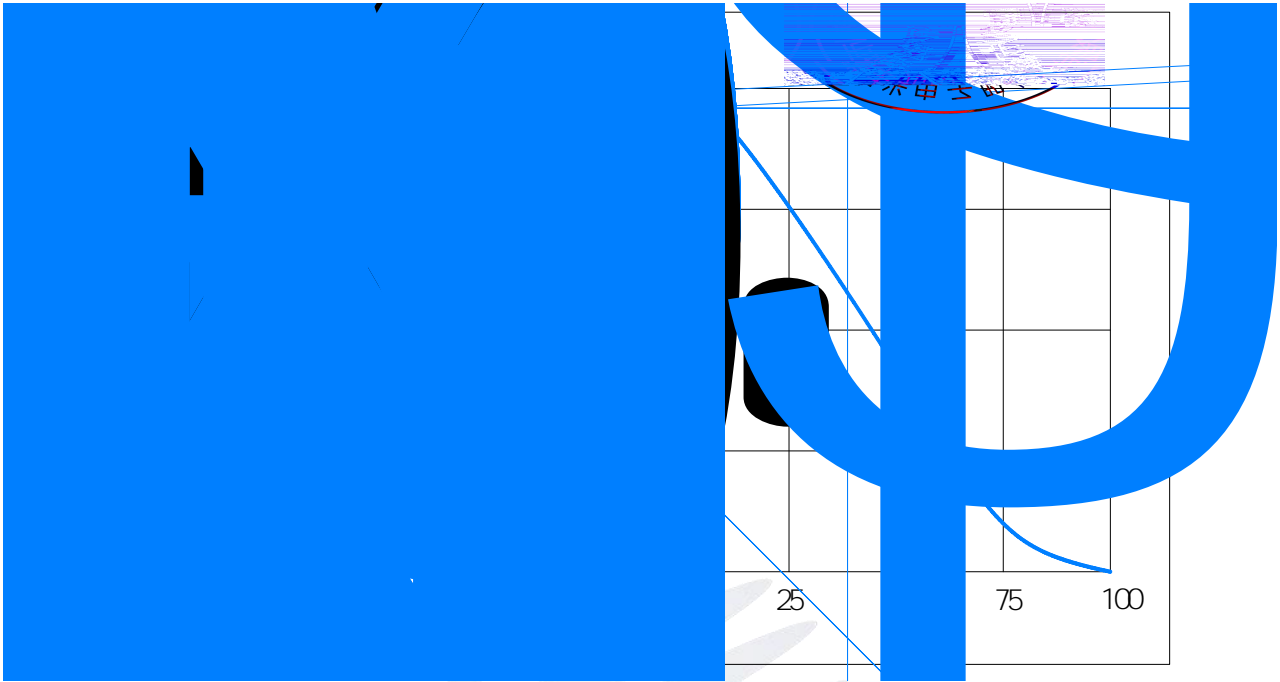

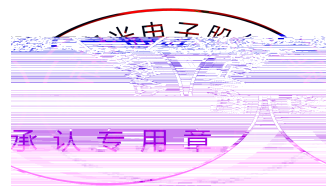
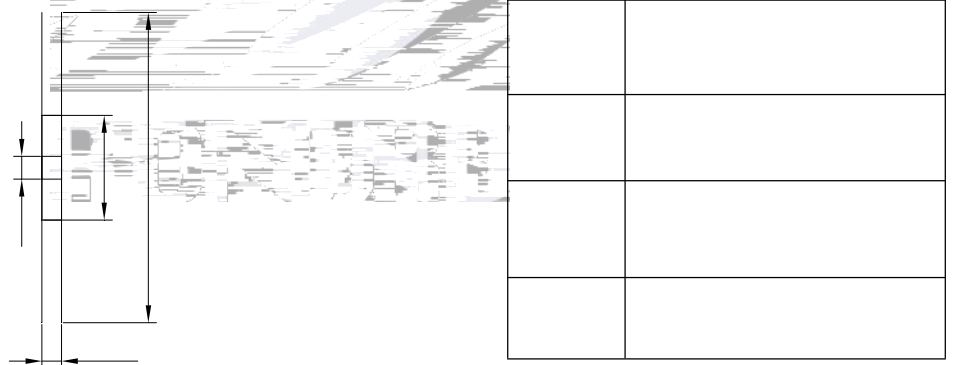
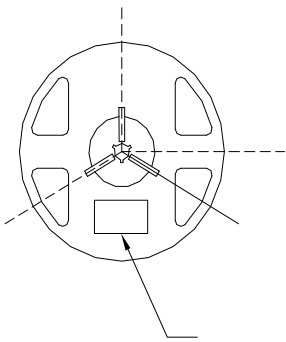
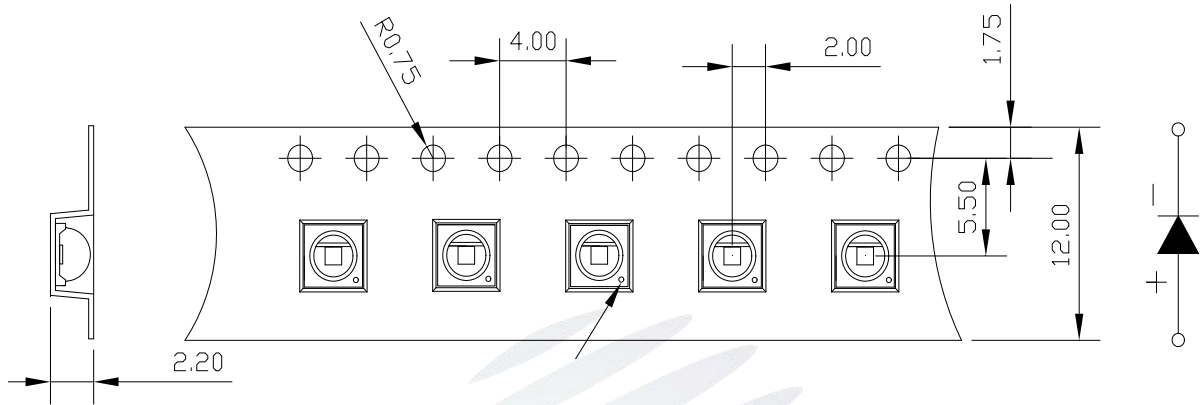

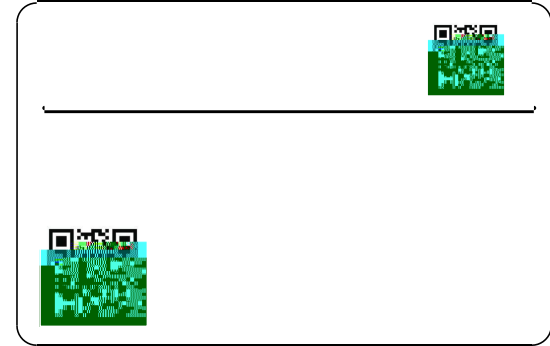

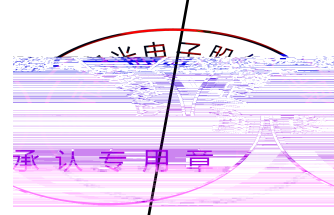
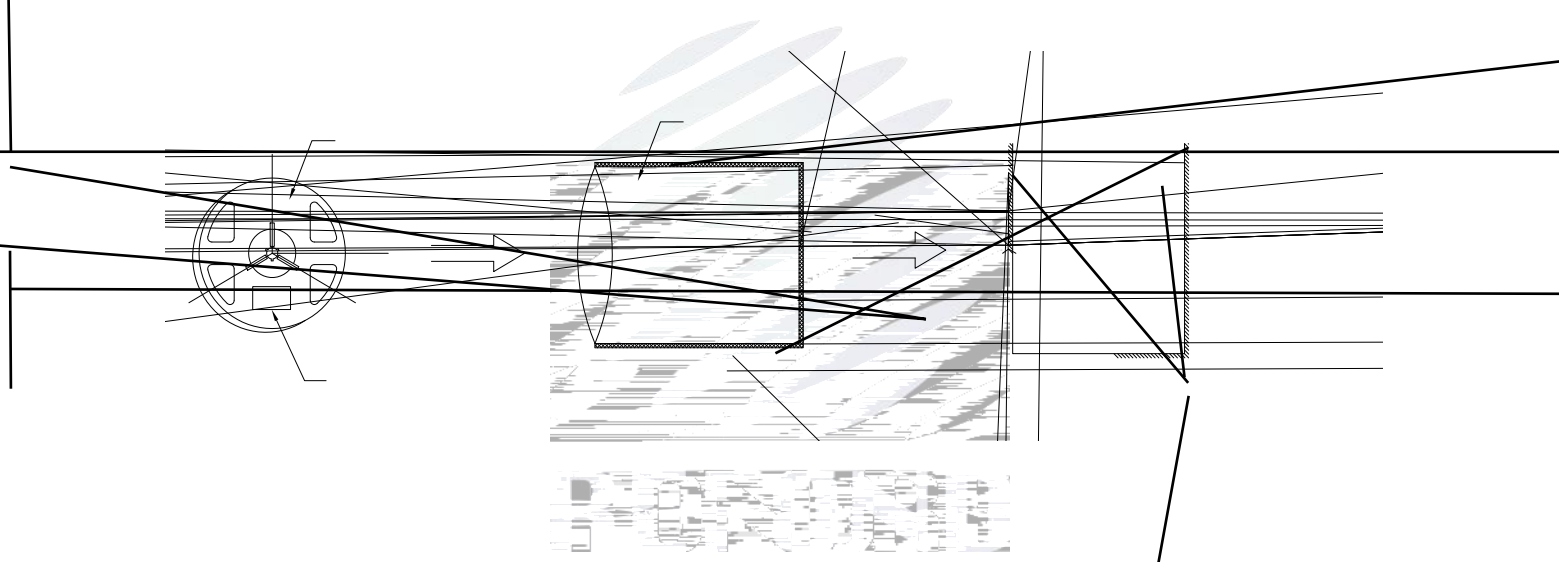



1.





瑞豐光電



°C

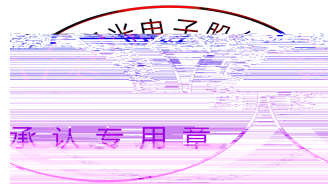

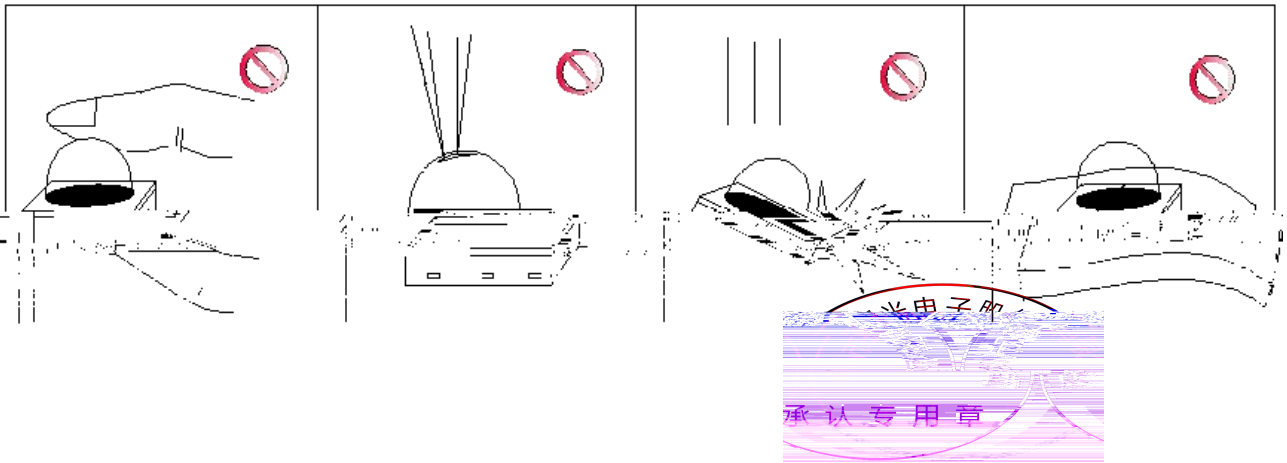

(7) () (±) °C

