

SPECIFICATION 产品规格书

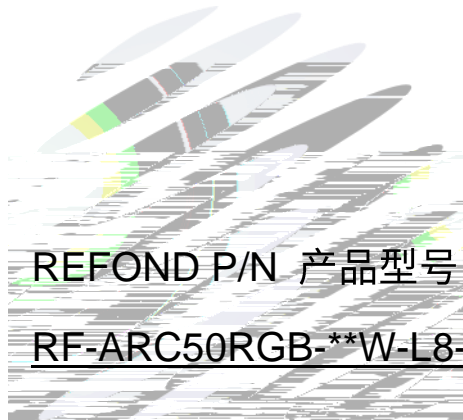

REFOND P/N 产品型号

RF-ARC50RGB-**W-L8-K0-A120

R&D 研发

Mass Product 量产供货

Contents 目录

1. Description 产品介绍	
1.1 General Description 产品描述	
1.2 Features 产品特征	
1.3 Application 应用领域	
1.4 Package Dimension 封装尺寸	
1.5 Product Parameters 产品参数	
1.5.1 Bin Range Of Forward Voltage and Luminous Intensity (IF=350mA)电压与光强分 BIN 范围 (IF=350mA)	
1.6 Typical optical characteristics curves 典型光学特性曲线	
2. Packaging 产品包装	
2.1 Packaging Specification 包装规格	
2.1.1 Carrier Tape Dimension 载带尺寸	15
2.1.2 Reel Dimension 卷盘尺寸	15
2.1.3 Label Form Specification 标签规格	16
2.2 Moisture Resistant Packing 防潮包装	
2.3 Cardboard Box 包装纸箱	
2.4 Reliability Test Items And Conditions 信赖性测试项目及条件	
2.5 Criteria For Judging Damage 失效判定标准	
3. SMT Reflow Soldering Instructions SMT 回流焊说明	
3.1 SMT Reflow Soldering Instructions SMT 回流焊说明	
4. Handling Precautions 产品使用注意事项	
4.1 Handling Precautions 产品使用注意事项	

产品介绍

产品描述

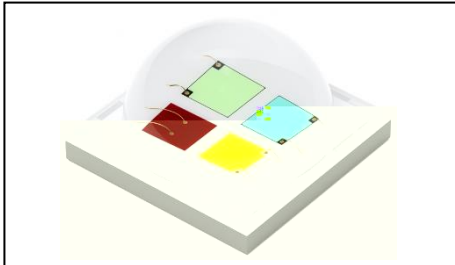

The Red source color devices are made with AlGaInP on Substrate Light Emitting Diode
红光 LED 由 AlGaInP 四种元素芯片激发而成

The Green source color devices are made with InGaN on Substrate Light Emitting Diode
绿光 LED 由 InGaN 三种元素芯片激发而成

The Blue source color devices are made with InGaN on Substrate Light Emitting Diode
蓝光 LED 由 InGaN 三种元素芯片激发而成

The White LED which was fabricated by using a blue chip and phosphors.
白光 LED 是由蓝光芯片激发蓝光粉而形成

The LED package dimension: 5.00mmX5.00mmX3.02mm.

产品尺寸：5.00mmX5.00mmX3.02mm。

产品特征

Ceramics Package.陶瓷封装

Extremely wide viewing angle.发光角度大

Suitable for all SMT assembly and solder process.适用于所有的SMT组装和焊接工艺

Available on tape and reel.适用于载带及卷轴

Moisture sensitive level:Level1. 防潮等级：Level 1

RoHS compliant.满足RoHS要求

产品应用

Article color lamp, lamp belt. 彩色灯条、灯带

Landscape lighting Trademark logo.景观照明, 招牌字

Hotels, markets, offices, household and other indoor uses.酒店、商场、办公室、家用及其它室内用途

General use.其他应用



封装尺寸

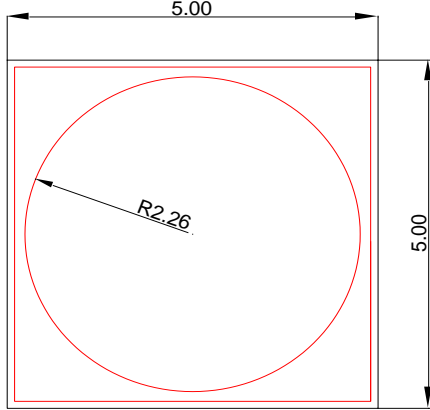

Fig.1-1 Top view 正面视图

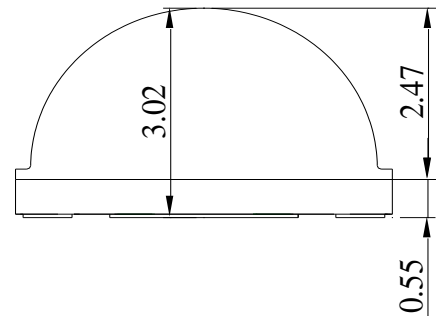

Fig.1-2 Side view 侧面视图

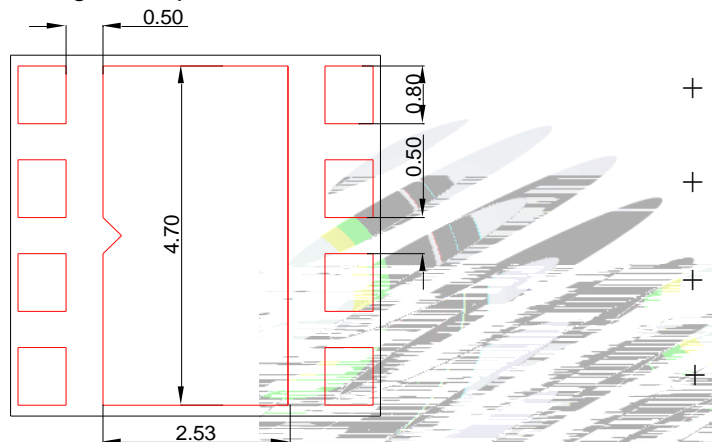

Fig.1-3 Bottom view 背面视图

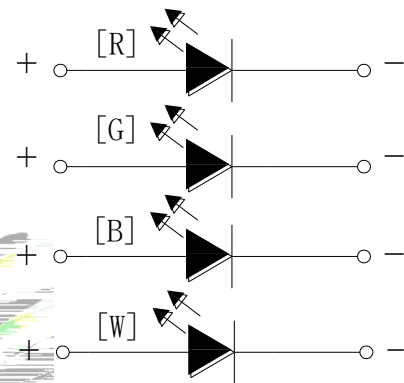

Fig.1-4 Polarity 极性

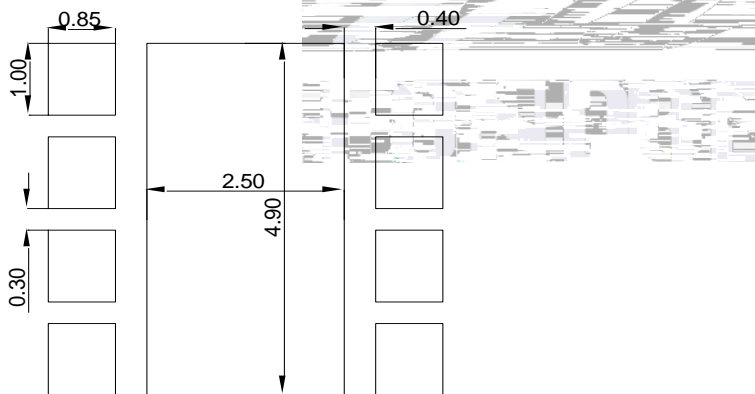

Fig.1-5 Soldering patterns 推荐焊盘

Notes 备注:

1. All dimensions units are millimeters. 所有尺寸标注单位为毫米
2. All dimensions tolerances are $\pm 0.2\text{mm}$ unless otherwise noted. 除特别标注外, 所有尺寸公差为 ± 0.2 毫米

1.5 Product Parameters 产品参数

Table 1-1 Electrical / Optical Characteristics at Ts=25°C 电性与光学特性

Item 项目	Symbol 符号	Test Condition 测试条件	Value			Unit 单位
			Min. (最小值)	Typ (典型值)	Max. (最大值)	
Forward Voltage R (正向电压)	V_F	$I_F=350\text{mA}$	1.8	---	2.6	V
Forward Voltage G&B (正向电压)	V_F	$I_F=350\text{mA}$	2.6	---	3.4	V
Forward Voltage W (正向电压)	V_F	$I_F=350\text{mA}$	2.6	---	3.4	V
Luminous Flux R (光通量)	Φ_v	$I_F=350\text{mA}$	50	---	90	lm
Luminous Flux G (光通量)	Φ_v	$I_F=350\text{mA}$	130	---	180	lm
Luminous Flux B (光通量)	Φ_v	$I_F=350\text{mA}$	30	---	50	lm
RF-ARC50RGB-27W-L8-K0-A120 Luminous Flux W (光通量)	Φ_v	$I_F=350\text{mA}$	110	---	150	lm
RF-ARC50RGB-30W-L8-K0-A120 Luminous Flux W (光通量)	Φ_v	$I_F=350\text{mA}$	110	---	150	lm
RF-ARC50RGB-35W-L8-K0-A120 Luminous Flux W (光通量)	Φ_v	$I_F=350\text{mA}$	120	---	160	lm

RF-ARC50RGB

RF-ARC50RGB-60W-L8-K0-A120 Luminous Flux W (光通量)	Φ_v	$I_F=350mA$	120	---	160	lm
--	----------	-------------	-----	-----	-----	----

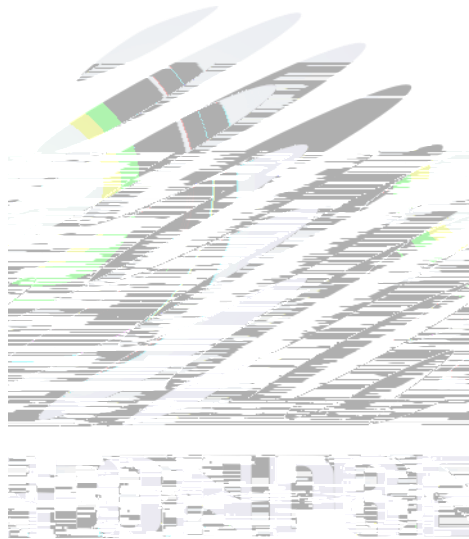

Table 1-2 Absolute Maximum Ratings at Ts=25°C 绝对最大值

Parameter (参数)	Symbol (符号)	Rating (值)	Units (单位)
Power Dissipation (功耗)	P_D	R:2600+G:3400+B:3400+W:3400	mW
Forward Current RGBW (正向电流)	I_F	1000	mA
Peak Forward Current RGBW (峰值电流)	I_{FP}	1250	mA
Reverse Voltage (反向电压)	V_R	5	V
Electrostatic Discharge (HBM) (静电)	E_{SD}	2000	V
Operating Temperature (操作温度)	T_{OPR}	-40 ~ +85	
Storage Temperature (储存温度)	T_{OPR}	-40 ~ +85	
Junction Temperature (结温) R	T_J	125	°C
Junction Temperature (结温) G	T_J	150	°C
Junction Temperature (结温) B	T_J	150	°C
Junction Temperature (结温) W	T_J	150	°C

Notes 备注:

- 1/10 Duty cycle, 0.1ms pulse width. 脉宽0.1ms, 占空比1/10.
- The above forward voltage measurement allowance tolerance is $\pm 0.1V$. 以上所示电压测量误差 $\pm 0.1V$.
- The above Dominant Wavelength measurement allowance tolerance is $\pm 1nm$. 以上所示波长测量误差 $\pm 1nm$.
- The above luminous intensity measurement allowance tolerance $\pm 10\%$. 上述发光强度的测试允许公差为 $\pm 10\%$.
- Care is to be taken that power dissipation does not exceed the absolute maximum rating of the product. 使用功率不能超过规定的最大值。

6. All measurements were made under the standardized environment of Refond. 所有的测试都是在瑞丰以标准测试平台。

7. When the LEDs are in operation the maximum current should be decided after measuring the package temperature. junction temperature should not exceed the maximum rate. LED 使用的最大电流需要根据散热条件确定, 结温不能超过最大值。

8. ESD yield is over 80% at 2000V ESD (HBM). ESD protection during products handing is needed. 80%的LED 通过人体模式ESD2000V 测试, 在操作时请注意静电防护。

1.5.1 Bin Range Of Forward Voltage and Luminous Intensity (IF=350mA)电压与光强分 BIN 范围(IF=350mA)

Table 1-3

V _F V R	B0	C0	D0	
	1.8-2.0	2.0-2.2	2.2-2.4	
V _F V G&B&W	G0	H0	I0	
	2.8-3.0	3.0-3.2	3.2-3.4	
&) R	FB7	FB8	FB9	FC0
	50-60	60-70	70-80	80-90
&) G	FC5	FC6	FC7	FC8
	130-140	140-150	150-160	160-170
	170-180			
&) B	FB5	FB6		
	30-40	40-50		
&) W	FC2	FC3	FC4	FC5
	100-110	110-120	120-130	130-140
	FC6	FC7		
	140-150	150-160		
WLD-R (nm)	E00	F00		
	620-625	625-630		
WLD-G (nm)	E00	F00		

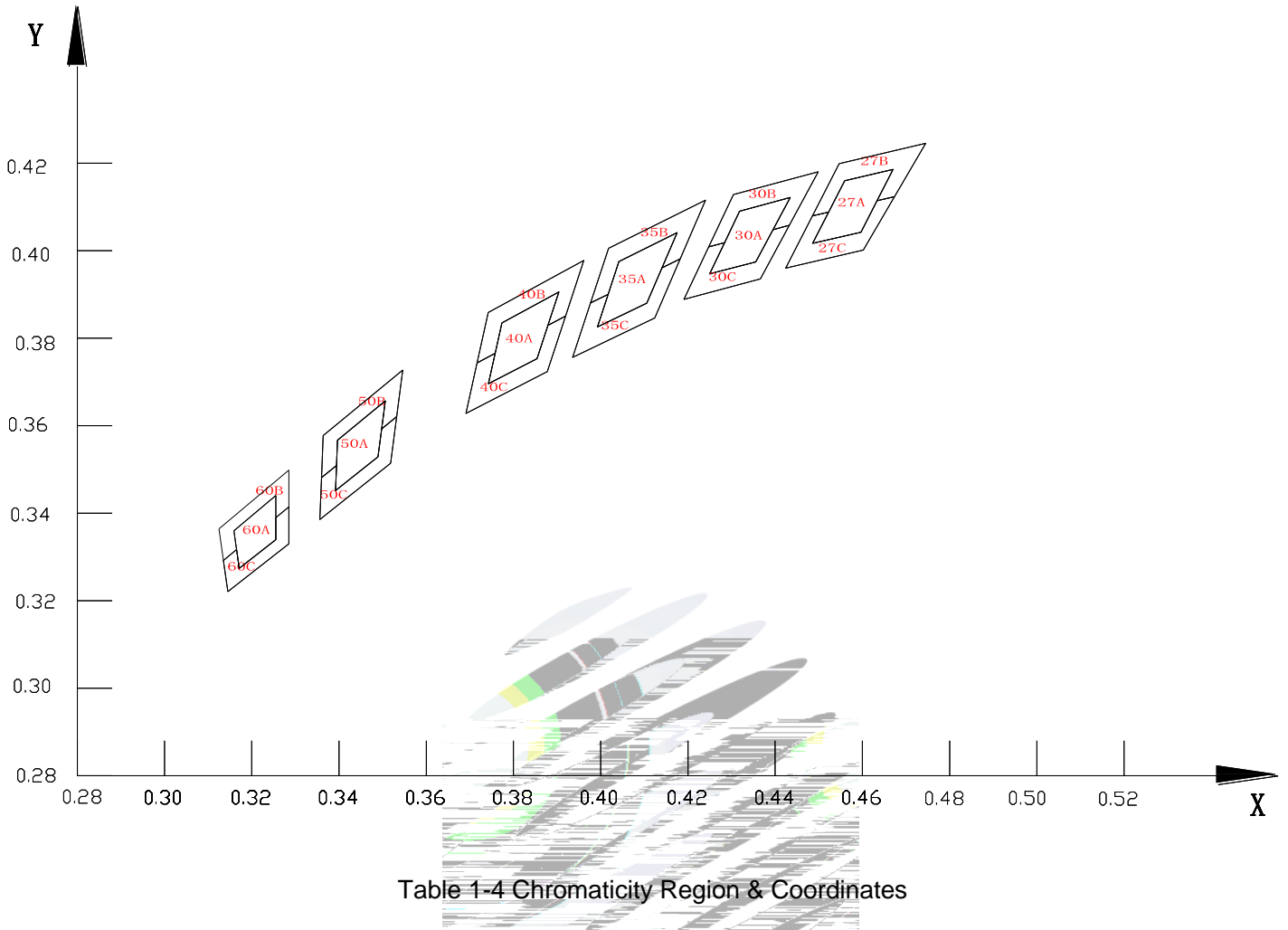

Table 1-4 Chromaticity Region & Coordinates

Region	CIE-X	CIE-Y	Region	CIE-X	CIE-Y	Region	CIE-X	CIE-Y	Region	CIE-X	CIE-Y
2700K			3000K			3500K			4000K		
27A	0.4559	0.4160	30A	0.4250	0.3947	35A	0.4042	0.3975	40A	0.3742	0.3696
	0.4670	0.4186		0.4318	0.4090		0.4175	0.4041		0.3773	0.3835
	0.4597	0.4042		0.4434	0.4122		0.4106	0.3880		0.3904	0.3906
	0.4486	0.4017		0.4355	0.3974		0.3993	0.3826		0.3854	0.3753
27B	0.4485	0.4079	30B	0.4248	0.4008	35B	0.3977	0.3881	40B	0.3716	0.3743
	0.4674	0.4123		0.4304	0.4128		0.4018	0.4005		0.3742	0.3859
	0.4745	0.4245		0.4499	0.4180		0.4240	0.4116		0.3961	0.3978



	0.4547	0.4199		0.4432	0.4058		0.4182	0.3981		0.3920	0.3851
27C	0.4424	0.3960	30C	0.4248	0.4008	35C	0.3977	0.3881	40C	0.3716	0.3743
	0.4602	0.4001		0.4191	0.3889		0.3936	0.3756		0.3691	0.3628
	0.4674	0.4123		0.4366	0.3935		0.4124	0.3846		0.3878	0.3724
	0.4485	0.4079		0.4432	0.4058		0.4182	0.3981		0.3920	0.3851
50A	0.3392	0.3452	60A	0.3171	0.3274						
	0.3397	0.3567		0.3159	0.3360						
	0.3506	0.3657		0.3255	0.3440						
	0.3489	0.3529		0.3255	0.3340						
50B	0.3360	0.3482	60B	0.3135	0.3292						
	0.3364	0.3577		0.3125	0.3364						
	0.3546	0.3727		0.3285	0.3499						
	0.3532	0.3621		0.3285	0.3414						
50C	0.3360	0.3482	60C	0.3135	0.3292						
	0.3356	0.3386		0.3145	0.3221						
	0.3518	0.3514		0.3285	0.3330						

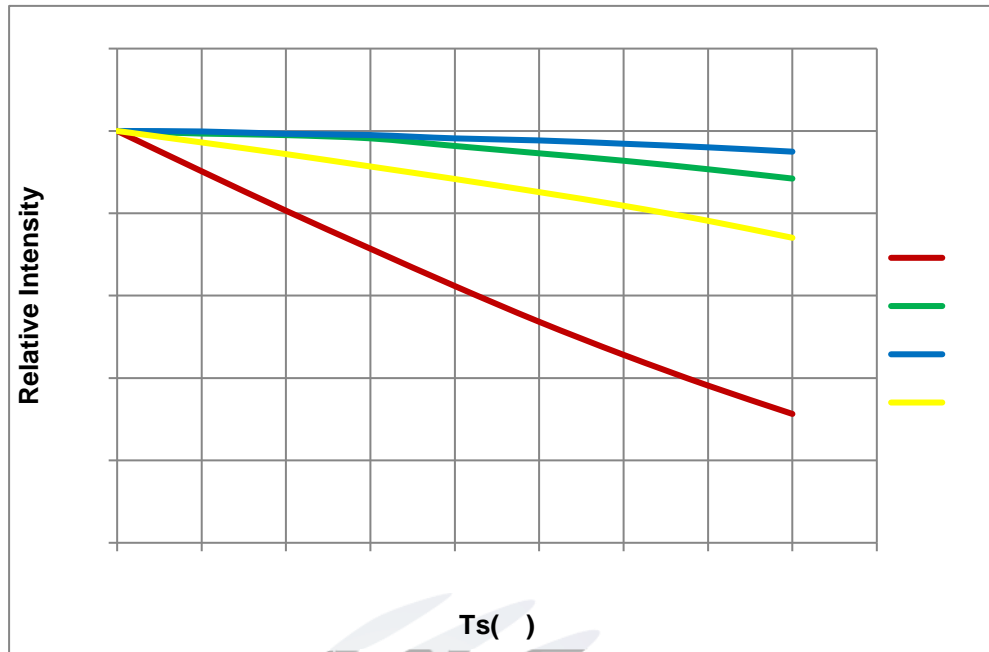

Fig.1-8 Temperature Vs Relative Intensity 引脚温度与相对光强特性曲线

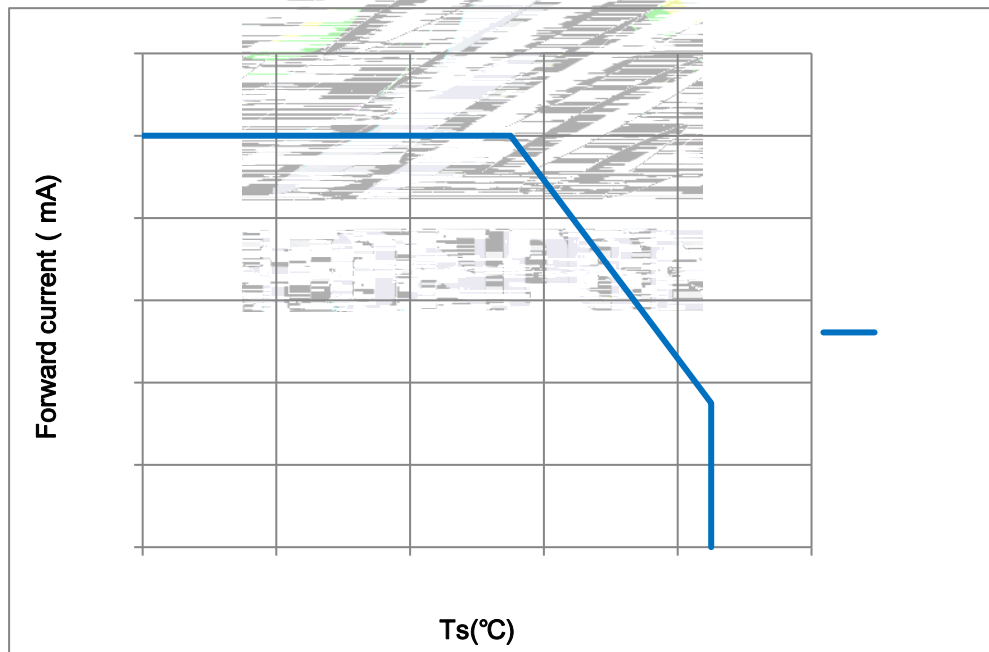
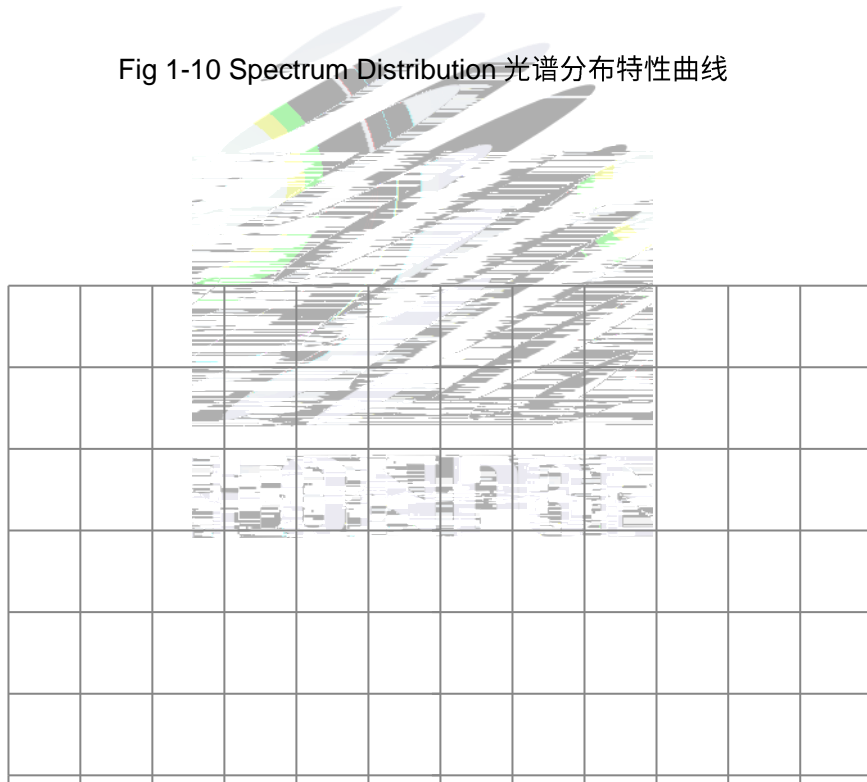

Fig 1-9 Ts Temperature Vs Forward Current 管脚温度与正向电流特性曲线

$T_j = 125^\circ\text{C}$

Fig 1-10 Spectrum Distribution 光谱分布特性曲线



辐射特性曲线

产品包装

包装规格

Package:1000pcs/reel.包装每卷

载带尺寸

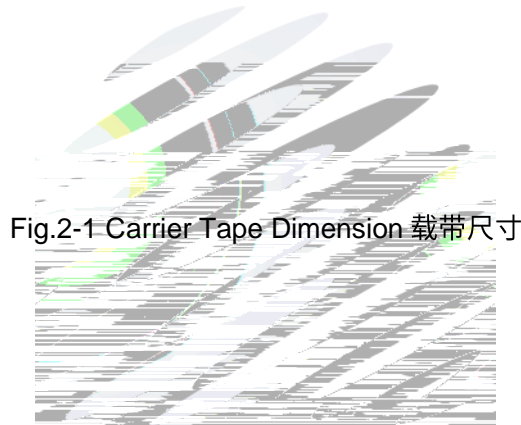

2.1.2 Reel Dimension 卷盘尺寸



Table 2-1 Reel Dimension 卷盘尺寸

A	14.0±0.5mm
B	178±1mm
C	59±1mm

Fig.2-2 Reel 卷盘

Notes 备注:

The tolerances unless mentioned ± 0.1 mm. Unit : mm 注: 未注公差为 ± 0.1 毫米, 尺寸单位: 毫米。

标签规格

Table 2-2 Title

PART NO.	Part Number 品名
SPEC NO.	Spec Number 规格
LOEMC350.ξ	

Fig 2-3 Label Form 标签模板

防潮包装



Fig.2-4Packing specification 包装说明



Fig.2-5Cardboard Box 包装纸箱



2.5 Criteria For Judging Damage 失效判定标准

Table 2-4 Criteria for judging damage 失效判定标准

Test Items 项目	Symbol 符号	Test Condition 测试条件	Criteria For Judgement 判定标准	Applicable project 适用项目
Forward Voltage 电压	V_F	$I_F=350\text{mA}$	$\leq \pm 10\%$	
Luminous Flux R	Φ_v	$I_F=350\text{mA}$	Maintenance $\geq 70\%$ 光通量维持率	Reflow
Luminous Flux G			Maintenance $\geq 70\%$ 光通量维持率	Thermal Shock
Luminous Flux B			Maintenance $\geq 50\%$ 光通量维持率	High and Low Temperature Storage
Luminous Flux W			Maintenance $\geq 80\%$ 光通量维持率	Life Test
Lamp Bead Light Test 灯珠点亮测试	/	$I_F=350\text{mA}$	No open circuit short circuit or flicke 无开路、短路、闪变	High Temperature High Humidity Life Test

Notes 备注:

1. The above reliability tests is based on the verification of a single/strip LED of Refond's existing experimental platform, the reliability experiment was taken under good heat dissipation conditions. when customers applies the LED to the series and parallel circuit, should take consideration of all the factors such as the current, voltage distribution, heat dissipation and others. 以上可靠性测试是基于瑞丰现有实验平台单颗/条 LED 在良好散热条件验证下的结果。客户端将 LED 应用于串、并联线路时，需自行评估电流、电压分配、散热等问题。

2.The technical information shown in the data sheets is limited to the typical characteristics and circuit examples of the referenced products. It does not constitute the warranting of industrial property nor the granting of any license. 以上技术数据仅为产品的典型值，只作为参考，不作为任何应用条件及应用方式的保证。



3. SMT Reflow Soldering Instructions SMT 回流焊说明

3.1 SMT Reflow Soldering Instructions SMT 回流焊说明

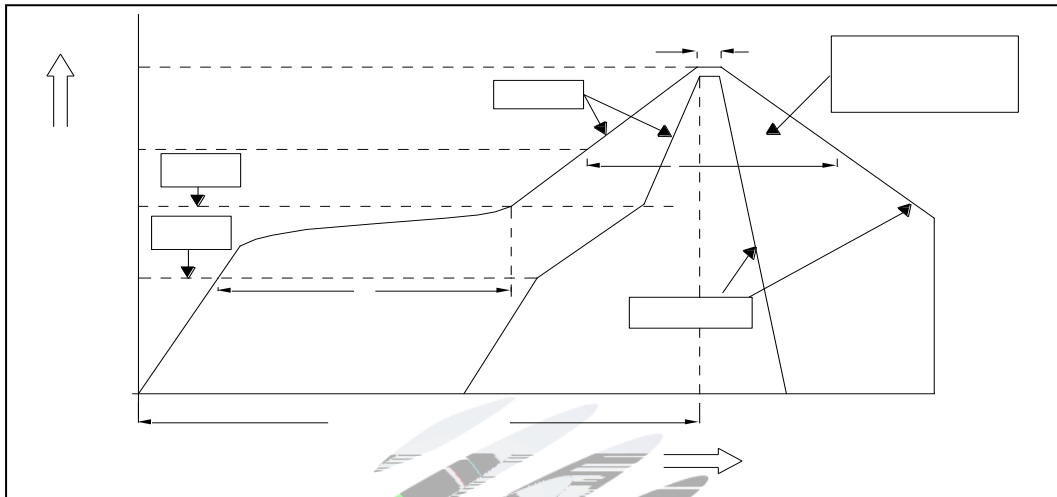

Fig.3-1 SMT Reflow Soldering Instructions SMT 回流焊说明

Table 3-1 SMT Reflow Soldering Parameter SMT 回流焊参数

平均升温速度 (T_{smax} 至 T_P)	最高 3 °C/ 秒
预热: 最低温度 (T_{smin})	150 °C
预热: 最高温度 (T_{smax})	200 °C
预热: 时间 (T_{smin} 至 T_{smax})	60 - 120 秒
限时维持高温: 温度 (T_L)	217 °C
限时维持高温: 时间 (t_l)	最多60 秒
峰值 / 尖峰温度 (T_P)	260 °C
限时峰值分类温度: 时间 (t_p)	最多10 秒
与实际峰值温度 (T_P) 相差 5 °C 以内的保持时间	最多30秒
降温速度	最高 6 °C/ 秒
25 °C 升至峰值温度所需时间	最多 8 分钟

Notes 备注:

(1) Reflow soldering should not be done more than twice. If more than 24 hours between the two solderings, LED will be damaged. 回流焊的次数不得超过两次，两次回流焊的时间间隔不得超过24小时，LED可能由于吸湿而损坏。

(2) When soldering, do not put stress on the LEDs during heating.当焊接时，不要在材料受热时用力压胶体表面。

3.1.1 Soldering Iron 烙铁焊接

(1) When do soldering by hand



(3) Do not apply mechanical force or excess vibration during the cooling process to normal temperature after soldering. Do not rapidly cool device after soldering. 回流焊之后冷却过程中，不要对材料施加外力，也不要震动，回流焊后，不要采用激剧冷却的方式。



4. Handling Precautions 产品使用注意事项

4.1 Handling Precautions 产品使用注意事项

(1) LED operating environment and sulfur element composition cannot be over 100PPM in the LED mating usage material. This is provided for informational purposes only and is not a warranty or endorsement. LED 工作环境及与 LED 适配的材料中硫元素及化合物成份不可超过 100PPM. 这只是一个建议, 不作任何品质担保。

(2) In order to prevent external material from getting into the inside of LED, which may cause the malfunction of LED, the single content of Bromine element is required to be less than 900PPM, the single content of Chlorine element is required to be less than 900PPM, the total content of Bromine element and Chlorine element in the external materials of the application products is required to be less than 1500PPM. This is provided for informational purposes only and is not a warranty or endorsement. 为了防止外界物质进入 LED 内部以造成 LED 的损伤, 所处环境及所用套件等等, 单一的溴元素含量要求小于 900PPM, 单一氯元素含量要求小于 900PPM, 溴元素与氯元素总含量必须小于 1500PPM. 这只是一个建议, 不作任何品质担保。

(3) VOCs (Volatile organic compounds) emitted from materials used in the construction of fixtures can penetrate silicone encapsulants of LEDs and discolor when exposed to heat and photonic energy. The result can be a significant loss of light output from the fixture. Knowledge of the properties of the materials selected to be used in the construction of fixtures can help prevent these issues. Refond advises against the use of any chemicals or materials that have been found or are suspected to have an adverse affect on device performance or reliability. To verify compatibility, Refond recommends that all chemicals and materials be tested in the specific application and environment for which they are intended to be used. Attaching LEDs, do not use adhesives that outgas organic vapor. 应用套件中的挥发性物质会渗透到 LED 内部, 在通电产生光子及热的条件下, 会导致 LED 变色, 进而造成严重光衰, 提前了解套件材料能够避免产生这些问题。瑞丰反对使用任何对 LED 有害的物质, 即使只是怀疑有害。针对特定的用途和使用环境, 瑞丰建议对所有的物质和材料进行相容性的测试。在贴装 LED 时候, 不要使用能产生有机挥发性气体的粘接剂。

(4) Handle the component along the side surface by using forceps or appropriate tools; do not directly touch or Handle the silicone lens surface, it may damage the internal circuitry. 通过使用适当的工具从材料侧面夹取，不可直接用手或尖锐金属压胶体表面，它可能会损坏内部电路。

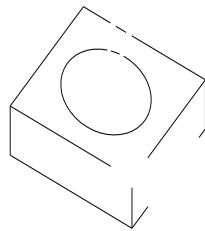

Fig 4-1 Misoperation 错误操作

(5) In designing a circuit, the current through each LED must exceed the absolute maximum rating specified for each LED. In the meanwhile, resistors for protection should be applied, otherwise slight voltage shift will cause big current change, burn out may happen. The driving circuit must be designed to allow forward voltage only when it is ON or OFF. If the reverse voltage is applied to LED, migration can be generated resulting in LED damage. 设计电路时，通过 LED 的电流不能超过规定的最大值，同时，还需使用保护电阻，否则，微小的电压变化将会引起电流变化，可能导致产品报废。电路设计必须保证只有在开启或者关闭的时候出现正向电压的变化，不要施加反压，否则会损坏 LED。

(6) Thermal Design is paramount importance because heat generation may result in the Characteristics decline, such as brightness decreased, Color change and so on. Please consider the heat generation of the LEDs when making the system design. LED 容易因为自身的发热和环境的温度改变而改变，温度升高会降低 LED 发光效率，影响发光颜色，所以在设计时应充分考虑散热问题。

(7) Compared to standard encapsulants, silicone is generally softer, and the surface is more likely to attract dust requiring special care during processing. In cases where a minimal level of dirt and dust particles cannot be guaranteed, a suitable cleaning solution must be applied to the surface after the soldering of components. Refond suggests using isopropyl alcohol for cleaning. In case other solvents are used, it must be assured that these solvents do not dissolve the package or resin. Ultrasonic cleaning is not recommended. Ultrasonic cleaning may cause

damage to the LED. 与其他封装胶相比，硅胶通常较软，表面易吸附脏物，应用时应特别注意，当清洗时，我们推荐用异丙醇作清洗剂！如对产品洁净度要求较高时，回流焊以后需要采用超声波清洗，需要用到其他清洗剂，必须保证不会破坏封装体，超声清洗可能会对 LED 带来损害，不推荐这种清洗方式。

Table 4-1 Storage 储存

Conditions 种类		Temperature 温度	Humidity 湿度	Time 时间
Storage 储存	Before Opening Aluminum Bag 拆包前	30°C	75%	Within 1 years From Date 1年内
	After Opening Aluminum Bag 拆包后	30°C	60%	168hours 168小时
Baking 烘烤		60±5°C	<5%	≥24hours 大于24小时

(8) If the moisture absorbent material silica gel has faded away or the LEDs have exceeded the storage time, baking treatment should be performed after unpacking and based on the following condition 60±5 and less than 5%RH for above 24 hours. 如果包装失效，如果干燥或者产品不符合以上有效储存条件，需拆包后进行烘烤，烘烤条件：60±5°C，小于 5%RH，大于 24 小时。

If the package is flatulence or damaged, please notify the sales staff to assist. 如果包装胀气或者

(9) Similar to most Solid state devices; LEDs are sensitive to Electro-Static Discharge (ESD) and Electrical Over Stress (EOS). 作为固体器件，LED 对静电过流击穿非常敏感，需要做好防护。

(10) Other points for attention, please refer to our relevant information. 其它注意事项请参照瑞丰相



Declare 申明

This specification is written both in English and in Chinese and the latter is formal.

产品规格书以中英文方式书写, 若出现冲突以中文版本!