

# SPECIFICATION 产品规格书

REFOND P/N 产品型号  
RF-AL-A28352H0DR-00

R&D 研发  
Mass Product 量产供货

## Contents 目錄

1. Description 产品介绍.....	3
1.1 General Description 产品描述.....	3
1.2 Features 产品特点.....	3
1.3 Application 产品应用.....	3
1.4 Package Dimension 封装尺寸.....	4
1.5 Product Parameters 产品参数.....	5
1.6 Bin Range Of Forward Voltage and Total radiant flux and Peak wavelength (IF=150mA) 电压与辐射通量与峰值波长分 BIN 范围(IF=150mA).....	6
1.7 Typical optical characteristics curves 典型光学特性曲线.....	7
2. Packaging 产品包装.....	11
2.1 Packaging Specification 包装规格.....	11
2.1.1 Carrier Tape Dimension 载带尺寸.....	11
2.1.2 Reel Dimension 卷盘尺寸.....	11
2.1.3 Label Form Specification 标签规格.....	12
2.2 Moisture Resistant Packing 防潮包装.....	12
2.3 Cardboard Box 包装纸箱.....	12
2.4 Reliability Test Items And Conditions 信赖性测试项目及条件.....	13
2.5 Criteria For Judging Damage 失效判定标准.....	14
3. SMT Reflow Soldering Instructions SMT 回流焊说明.....	15
3.1 SMT Reflow Soldering Instructions SMT 回流焊说明.....	15
4. Handling Precautions 产品使用注意事项.....	17
4.1 Handling Precautions 产品使用注意事项.....	17

## 1. Description 产品介绍

### 1.1 General Description 产品描述

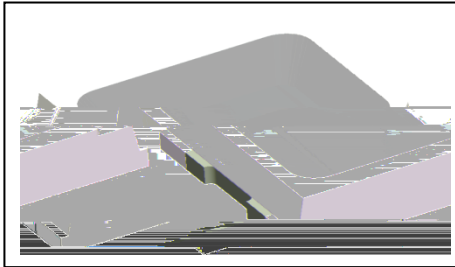

The Deep Red source color devices are made with AlInGaP on Substrate Light Emitting Diode.

Product package 2.8mmX3.5mmX0.65mm

深红光LED由AlInGaP四种元素芯片激发而成，产品尺寸：2.8mmX3.5mmX0.65mm

### 1.2 Features 产品特征

PLCC Package. PLCC封装

Extremely wide viewing angle. 发光角度大

Suitable for all SMT assembly and solder process. 适用于所有的SMT组装和焊接工艺

Available on tape and reel. 适用于载带及卷轴

Moisture sensitivity level: Level 3. 防潮等级 Level 3

RoHS compliant. 满足RoHS要求

### 1.3 Application 产品应用

Plant factory. 植物工厂

Tissue culture. 组织培养

Landscape lighting. 景观照明等

General use. 其他各种应用

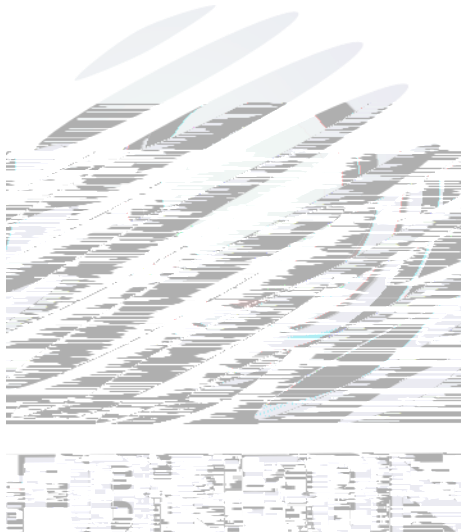

## 1.5 Product Parameters 产品参数

Table 1-1 Electrical / Optical Characteristics at Ts=25°C 电性与光学特性

Item 项目	Symbol 符号	Test Condition 测试条件	Value			Unit 单位
			Min. (最小值)	Typ (典型值)	Max. (最大值)	
Forward Voltage (正向电压)	$V_F$	$I_F=150\text{mA}$	1.8	---	2.6	V
Reverse Current (反向电流)	$I_R$	$V_R=5\text{V}$	---	---	10	$\mu\text{A}$
RF-AL-A28352H0DR-00 Total radiant flux (辐射功率)	$e$	$I_F=150\text{mA}$	70	---	160	mW
Viewing Angle (发光角度)		$I_F=150\text{mA}$	---	120	---	deg
Peak wavelength (峰值波长)	$\lambda_p$	$I_F=150\text{mA}$	655	---	670	nm
Thermal Resistance. (热阻)	$R_{THJ-S}$	$I_F=150\text{mA}$	---	35	---	$^{\circ}\text{C}/\text{W}$

Table 1-2 Absolute Maximum Ratings at Ts=25°C 绝对最大值

Parameter (参数)	Symbol (符号)	Rating (值)	Units (单位)
Power Dissipation (功耗)	$P_D$	468	mW
Forward Current (正向电流)	$I_F$	180	mA
Peak Forward Current (峰值电流)	$I_{FP}$	300	mA
Reverse Voltage (反向电压)	$V_R$	5	V
Electrostatic Discharge (HBM) (静电)	$E_{SD}$	2000	V
Operating Temperature (操作温度)	$T_{OPR}$	-40 ~ +85	
Storage Temperature (储存温度)	$T_{OPR}$	-40 ~ +100	

Junction Temperature  
(结温)

$T_j$

115

Notes 备注:

1. 1/10 Duty cycle, 0.1ms pulse width. 脉宽0.1ms,占空比1/10.
2. The above forward voltage measurement allowance tolerance is  $\pm 0.1V$ . 以上所示电压测量误差  $\pm 0.1V$ .
3. The above wavelength measurement allowance tolerance is  $\pm 1nm$ . 以上所示波长测量误差  $\pm 1nm$ .
4. The above Total radiant flux measurement allowance tolerance  $\pm 10\%$ . 上述辐射功率的测试允许公差为 $\pm 10\%$ .
5. Care is to be taken that power dissipation does not exceed the absolute maximum rating of the product. 使用功率不能超过规定的最大值。
6. All measurements were made under the standardized environment of Refond. 所有测试都是基于瑞丰现有的标准测试平台。
7. When the LEDs are in operation the maximum current should be decided after measuring the package temperature, junction temperature should not exceed the maximum rate. LED 使用的是大电流需要根据散热条件确定, 结温不能超过最大值。

## 1.6 Bin Range Of Forward Voltage and Total radiant flux and Peak wavelength (IF=150mA) 电压与辐射通量与峰值波长分 BIN 范围(IF=150mA)

Table 1-3

$V_F$ V	B1	B2	C1	C2	D1	D2	E1	E2
	1.8-1.9	1.9-2.0	2.0-2.1	2.1-2.2	2.2-2.3	2.3-2.4	2.4-2.5	2.5-2.6
RF-AL-A28352H0DR-00 p	R10	R11	R12	/	/	/	/	/
	655-660	660-665	665-670	/	/	/	/	/
RF-AL-A28352H0DR-00 e mW	DR2	DR3	DR4	/	/	/	/	/
	70-110	110-130	130-160	/	/	/	/	/

### 1.7 Typical optical characteristics curves 典型光学特性曲线

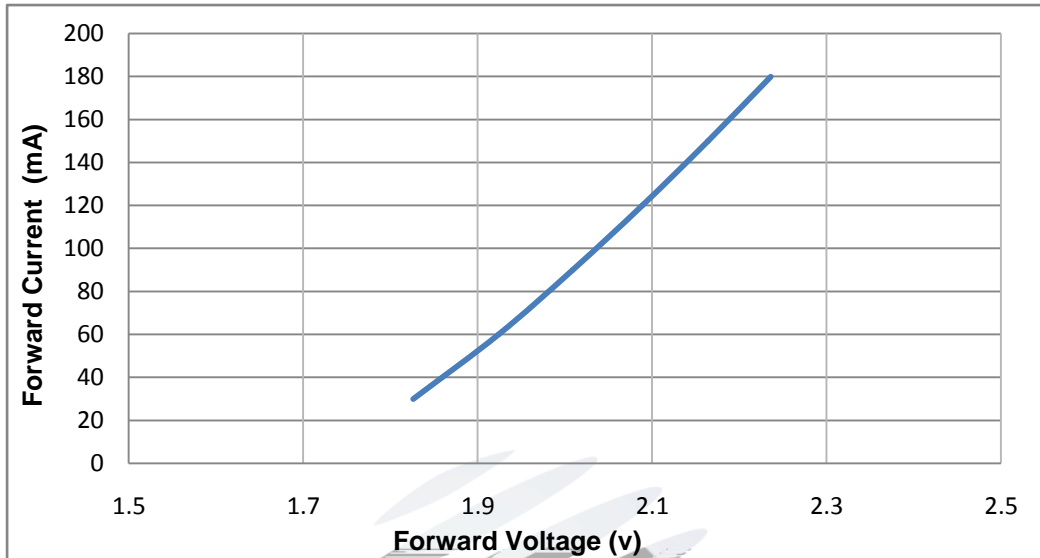

Fig 1-7 Forward Voltage Vs. Forward Current 伏安特性曲线

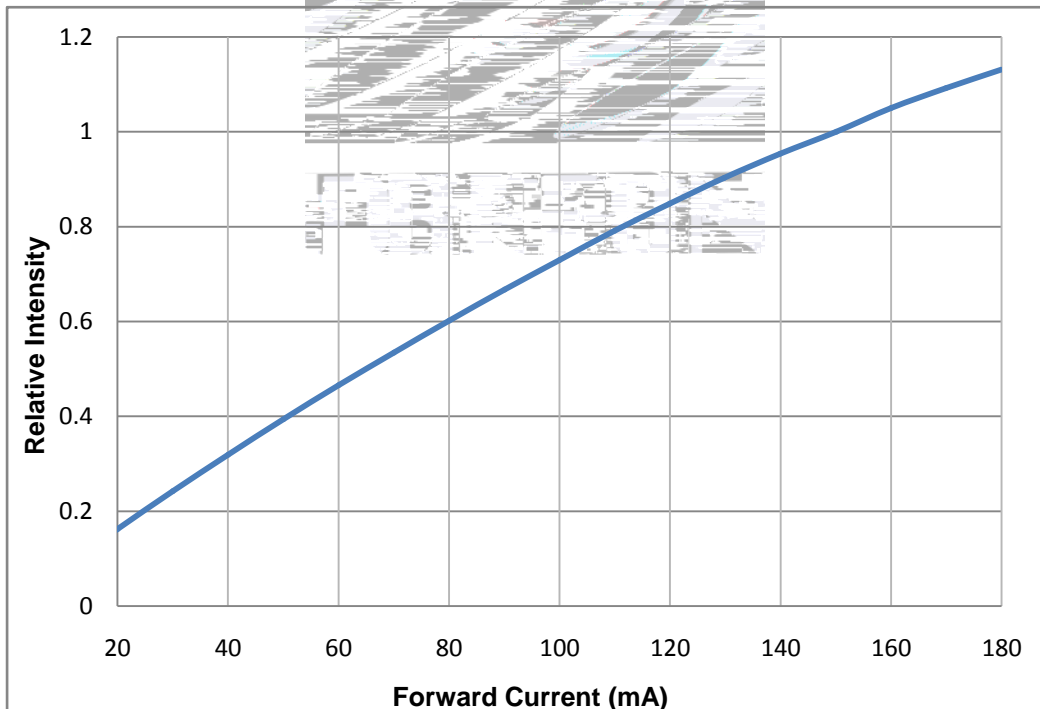

Fig 1-8 Forward Current Vs. Relative Intensity 正向电流与相对光强特性曲线

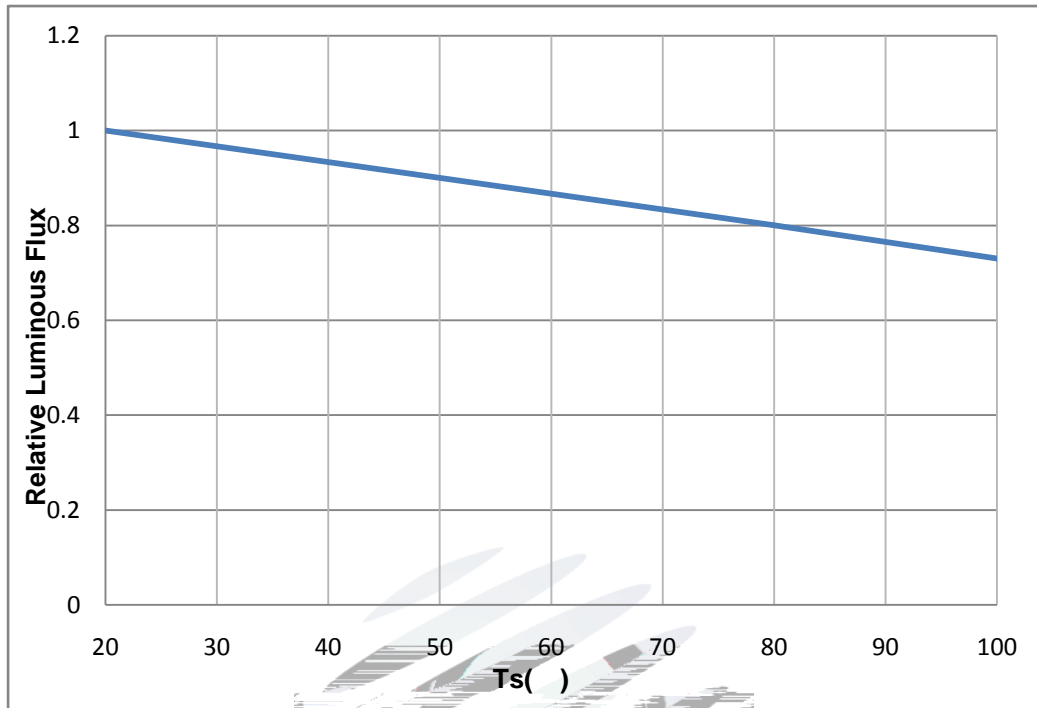

Fig 1-9 Solder Temperature Vs Relative Intensity 管脚温度与相对光强特性曲线

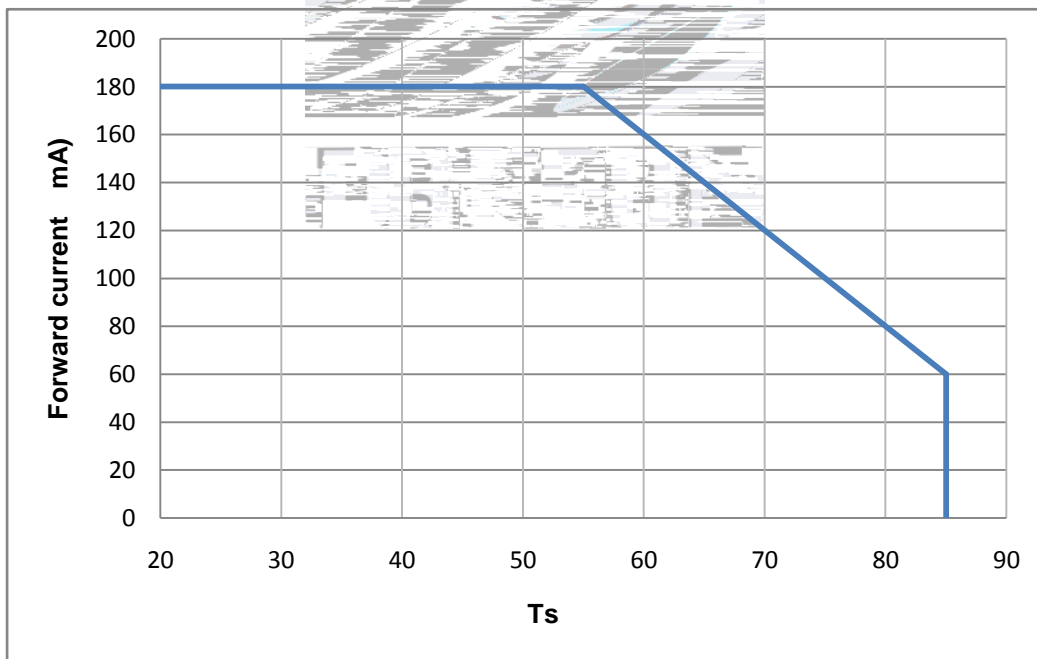

Fig 1-10 Solder Temperature Vs Forward Current 管脚温度与正向电流特性曲线



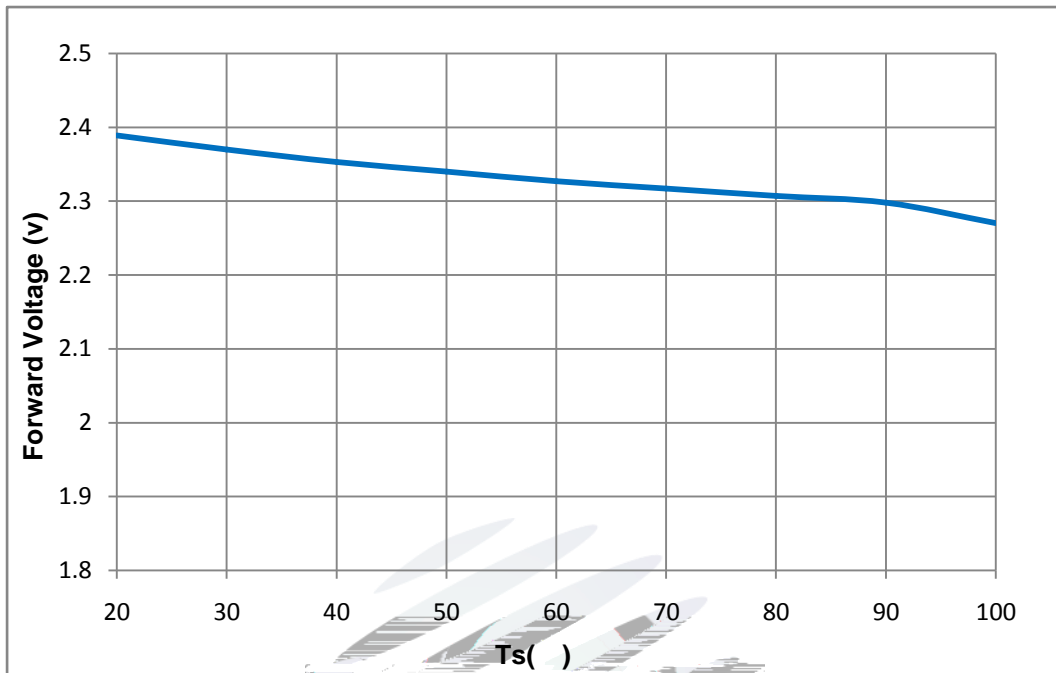

Fig 1-11 Forward Voltage Vs. Solder Temperature 电压与管脚温度特性曲线

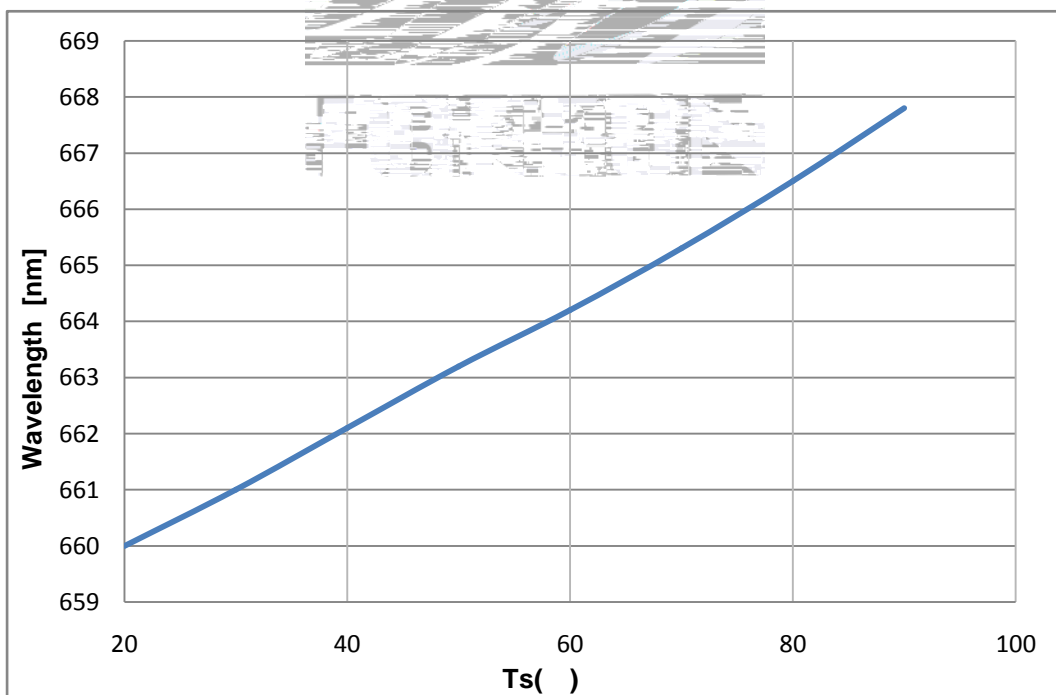

Fig 1-12 Wavelength Vs. Pin Temperature 波长与引脚温度特性曲线

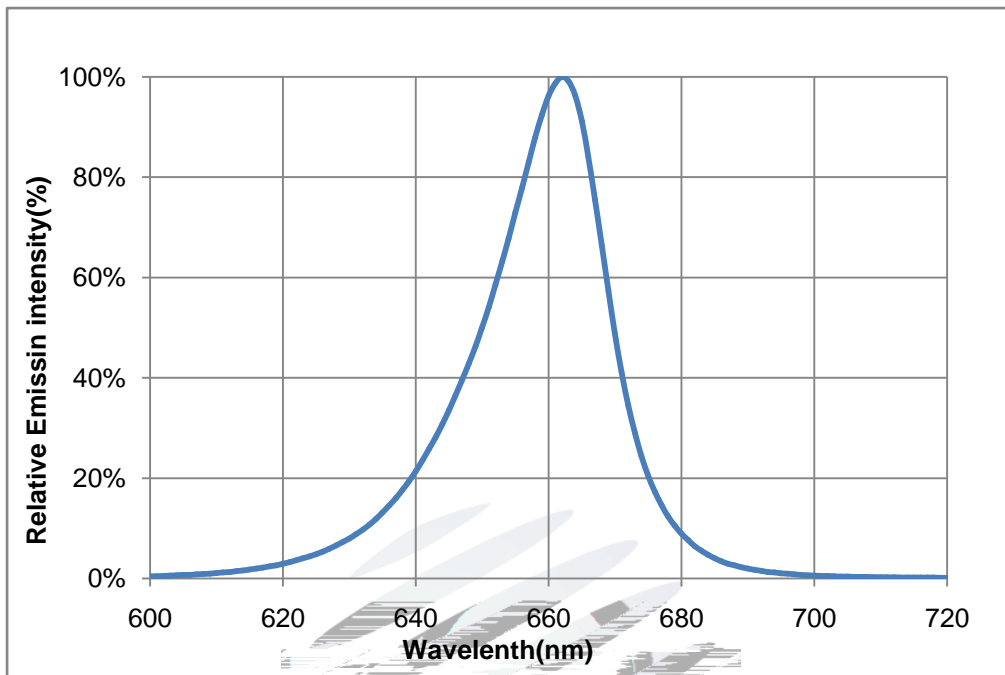
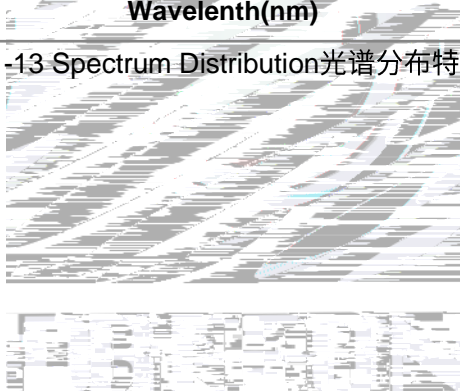

Fig 1-13 Spectrum Distribution 光谱分布特性曲线



## 2. Packaging 产品包装

### 2.1 Packaging Specification 包装规格

Package:Max 4000pcs/reel.包装每卷最多 4000pcs。

#### 2.1.1 Carrier Tape Dimension 载带尺寸

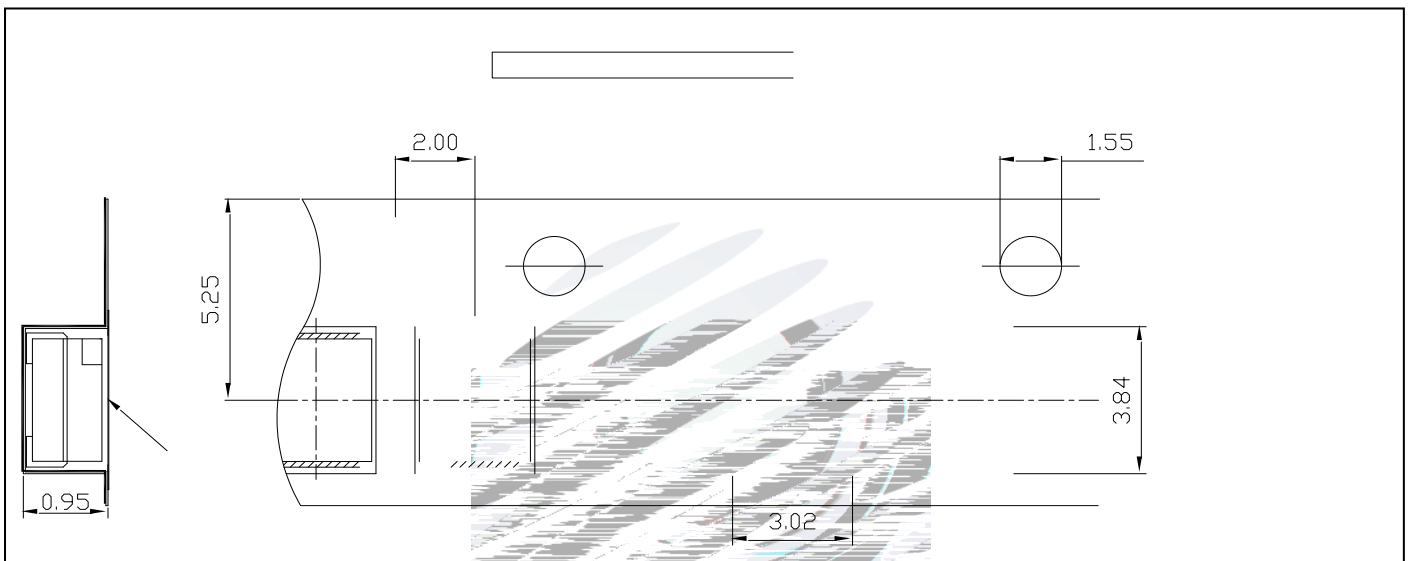

Fig.2-1 Carrier Tape Dimension 载带尺寸

#### 2.1.2 Reel Dimension 卷盘尺寸

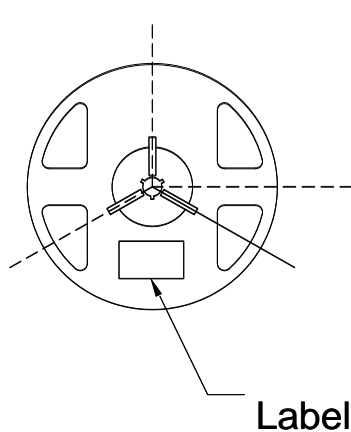

Fig.2-2 Reel 卷盘

Table 2-1 Reel Dimension 卷盘尺寸

A	10.5±0.5mm
B	178±1mm
C	59±1mm
D	13.5±0.5mm

Notes 备注:

The tolerances unless mentioned  $\pm 0.1\text{mm}$ . Unit : mm 注：未注公差为 $\pm 0.1$

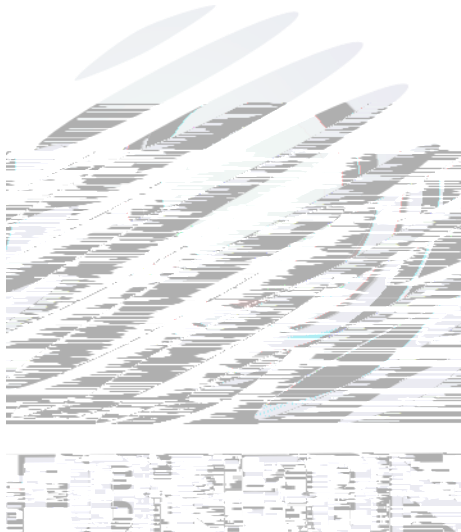

## 2.4 Reliability Test Items And Conditions 信賴性測試項目及條件

Table 2-2 Test items and conditions 測試項目及條件

Test Items 項目	Ref. Standard 參考標準	Test Condition 測試條件	Time 時間	Quantity 數量	Ac/Re 接收/拒收
Reflow 回流焊	JESD22-B106	Temp:260°Cmax T=10 sec	2times	10pcs.	0/1
Thermal Shock 冷熱衝擊	JESD22-A106	-40°C 15min 10s 100°C 15min	100 cycle	10pcs.	0/1
High Temperature Storage 高溫保存	JESD22-A103	Temp:100°C	1000hrs.	10pcs.	0/1
Low Temperature Storage 低溫保存	JESD22-A119	Temp:-40°C	1000hrs.	10pcs.	0/1
Life Test 常溫測試	JESD22-A108	Ta=25°C If=150mA	1000hrs.	10pcs.	0/1
High Temperature High Humidity Life Test 高溫高濕測試	JESD22-A101	60°C/ 90%RH If=150mA	500hrs.	10pcs.	0/1

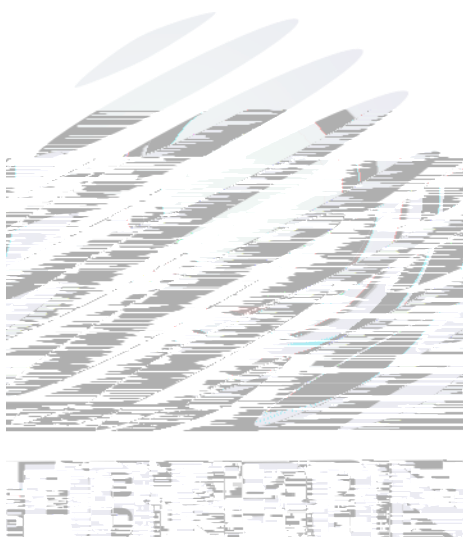

### 3. SMT Reflow Soldering Instructions SMT 回流焊说明

#### 3.1 SMT Reflow Soldering Instructions SMT 回流焊说明

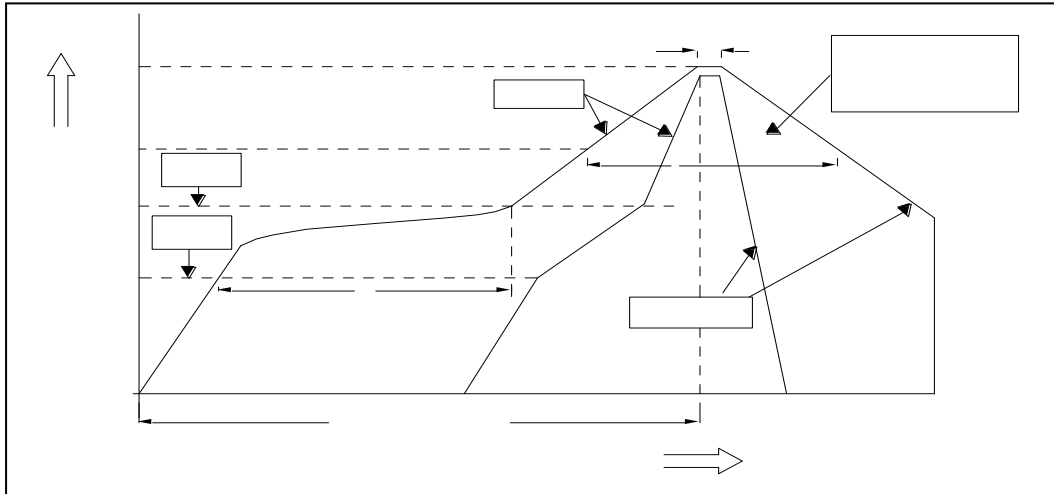

Fig.3-1 SMT Reflow Soldering Instructions SMT 回流焊说明

Table 3-1 SMT Reflow Soldering parameters SMT 回流焊参数

Average temperature rise speed 平均升温速度 (T <sub>max</sub> 至T <sub>P</sub> )	最高3°C/秒 Max 3 °C/ s
Preheating: minimum temperature 预热: 最低温度 (T <sub>min</sub> )	150 °C
Preheating: Max temperature 预热: 最高温度 (T <sub>max</sub> )	200 °C
Preheating: Time 预热: 时间 (T <sub>min</sub> 至T <sub>max</sub> )	60 - 120秒 60s-120s
Time limited to maintain high temperature: the temperature 限时维持高温: 温度 (T <sub>L</sub> )	217 °C
Time limited to maintain high temperature: The Time 限时维持高温: 时间 (t <sub>L</sub> )	最多60秒 Max 60s
Peak /Classification of temperature:峰值 / 分类温度 (T <sub>P</sub> )	260 °C
Time limit classification of peak temperature time 限时峰值分类温度: 时间 (t <sub>p</sub> )	最多10秒 Max 10s
与实际峰值温度 (T <sub>P</sub> ) 相差 5 °C 以内的保持时间 Hold time within 5 °C with the actual peak temperature (TP)	最多30秒 Max 30s

降温速度      Cooling speed	最高6 °C/秒 Max 6 °C/ s
25 °C 升至峰值温度所需时间 Tp	Needed time from 25 °C to 最多8分钟 Max 8minutes

Notes 备注:

(1)Reflow soldering should not be done more than two times. In the case of more than 24 hours passed soldering after first, LEDs will be damaged. 回流焊次数不可以超过两次，两次回流焊的时间间隔如果超过24小时，LED可能由于吸湿而损坏。

(2)Whensoldering , do not put stress on the LEDs during heating.当焊接时，不要在材料受热时用力压胶体表面。

### 3.1.1 Soldering Iron 烙铁焊接

(1) When hand soldering, keep the temperature of iron below less 300°C less than 3 seconds 当手工焊接时，烙铁的温度必须小于300°C，时间不可超过3秒。

(2) The hand solder should be done only one time.手工焊接只可焊接一次。

### 3.1.2 Repairing

Repair should not be done after the LEDs have been soldered. When repairing is unavoidable,a double-head soldering iron should be used (as below figure). It should be confirmed in advance whether the characteristics of LEDs will or will not be damaged by repairing.

LED 焊接后不可再进行维修，当必须维修时，必须使用双头烙铁，而且不能用力压胶体，否则会损坏LED本身的特性。

### 3.1.3 Cautions 注意事项

(1) The encapsulated material of the LEDs is silicone. Therefore the LEDs have a soft surface on the top of package. The pressure to the top surface will be influence to the reliability of the LEDs. Precautions should be taken to avoid the strong pressure on the encapsulated part. So when use the picking up nozzle, the pressure on the silicone resin should be proper. LED封装胶为硅胶，



表面较软，用力按压胶体表面会影响LED可靠性，因此应有预防措施避免在按压器件，当使用吸嘴时，胶体表面的压力应是恰当的。

(2) Do not apply mechanical force or excess vibration during the cooling process to normal temperature after soldering. Do not rapidly cool device after soldering. 回流焊之后冷却过程中，不要对材料施加外力，也不要震动，回流焊后，不要采用激剧冷却的方式。

## 4. Handling Precautions 产品使用注意事项

### 4.1 Handling Precautions 产品使用注意事项

(1) LED operating environment and sulfur element composition cannot be over 100PPM in the LED mating usage material. This is provided for informational purposes only and is not a warranty or endorsement. LED 工作环境及与 LED 适配的材料中硫元素及化合物成份不可超过 100PPM. 这只是一个建议，不作任何品质担保。

(2) In order to prevent external material from getting into the inside of LED, which may cause the malfunction of LED, the single content of Bromine element is required to be less than 900PPM, the single content of Chlorine element is required to be less than 900PPM, the total content of Bromine element and Chlorine element in the external materials of the application products is required to be less than 1500PPM. This is provided for informational purposes only and is not a warranty or endorsement. 为了防止外界物质进入 LED 内部以造成 LED 的损伤，所处环境及所用套件等等，单一的溴元素含量要求小于 900PPM，单一氯元素含量要求小于 900PPM，溴元素与氯元素总含量必须小于 1500PPM. 这只是一个建议，不作任何品质担保。

(3) VOCs (Volatile organic compounds) emitted from materials used in the construction of fixtures can penetrate silicone encapsulants of LEDs and discolor when exposed to heat and photonic energy. The result can be a significant loss of light output from the fixture. Knowledge of the properties of the materials selected to be used in the construction of fixtures can help prevent these issues. Refond advises against the use of any chemicals or materials that have been found or are suspected to have an adverse affect on device performance or reliability. To verify compatibility, Refond recommends that all chemicals and materials be tested in the specific application and environment for which they are intended to be used. Attaching LEDs, do not use

adhesives that outgas organic vapor. LED 内部，在通电产生光子及热的条件下，会导致 LED 变色，进而造成严重光衰，提前了解套件材料能够避免产生这些问题。瑞丰反对使用任何对 LED 器件的性能或者可靠性有害的物质或材料，不管这些材料是已经证实了的还是仅仅怀疑有害。针对特定的用途和使用环境，瑞丰建议对所有的物质和材料进行相容性的测试。在贴装 LED 时候，不要使用能产生有机挥发性气体的粘结剂。

(4) Handle the component along the side surface by using forceps or appropriate tools; do not directly touch or Handle the silicone lens surface, it may damage the internal circuitry. 通过使用适当的工具从材料侧面夹取，不可直接用手或尖锐金属压胶体表面，它可能会损坏内部电路。

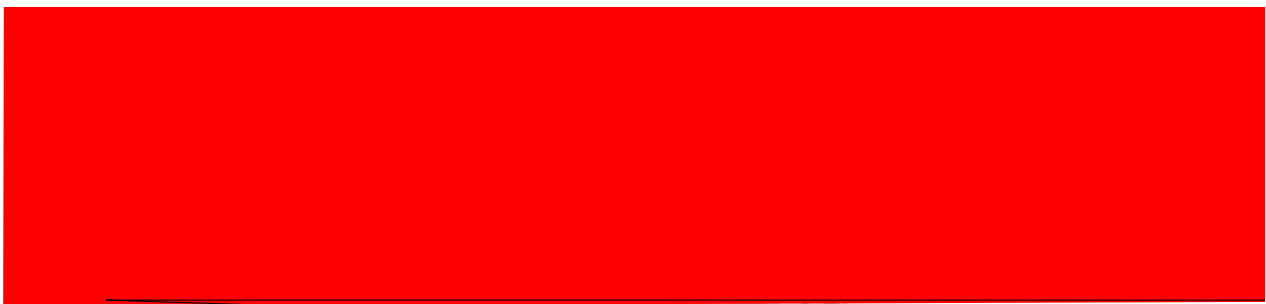

Fig 4-1 Misoperation 错误操作

(5) In designing a circuit, the current through each LED can not be exceed the absolute maximum rating specified for each LED. In the meanwhile, resistors for protection should be applied, otherwise slight voltage shift will cause big current change, burn out may happen. The driving circuit must be designed to allow forward voltage only when it is ON or OFF. If the reverse voltage is applied to LED, migration can be generated resulting in LED damage. 设计电路时，通过 LED 的电流不能超过规定的最大值，同时，还需要使用保护电阻，否则，微小的电压变化将会引起较大电流变化，可能导致产品损毁。电路设计必须保证只有在开启或者关闭的时候出现正向电压的变化，不要施加反压，否则会损坏 LED。

(6) Thermal Design is paramount importance because heat generation may result in the Characteristics decline, such as brightness decreased, Color change and so on. Please consider the heat generation of the LEDs when making the system design. LED 容易因为自身的发热和环境的温度改变而改变，温度升高会降低 LED 发光效率，影响发光颜色，所以在设计时应充分考虑散热问题。

(7) Compared to standard encapsulants, silicone is generally softer, and the surface is more likely to attract dust, requiring special care during processing. In cases where a minimal level of dirt and dust particles cannot be guaranteed, a suitable cleaning solution must be applied to the surface after the soldering of components. Refond suggests using isopropyl alcohol for cleaning. In case other solvents are used, it must be assured that these solvents do not dissolve the package or resin. Ultrasonic cleaning is not recommended. Ultrasonic cleaning may cause damage to the LED. 与其他封装胶相比，硅胶通常较软，表面易吸附脏物，应用时应特别注意，当对产品洁净度要求较高时，回流焊以后需再采用恰当清洗方式，我们推荐用异丙醇作清洗剂，如需要用到其他清洗剂，必须保证不会破坏封装体，超声清洗可能会对 LED 带来损害，不推荐这种清洗方式。

Table 4-1 Storage 储存

Conditions 种类		Temperature 温度	Humidity 湿度	Time 时间
Storage	Before Opening Aluminum Bag 拆包前	$\leq 30^{\circ}\text{C}$	$\leq 75\%$	Within 1 Year From Date 一年内
	After Opening Aluminum Bag 拆包后	$\leq 30^{\circ}\text{C}$	$\leq 60\%$	24hours 24小时
Baking 烘烤		$60 \pm 5^{\circ}\text{C}$	-	$\geq 24\text{hours}$ 大于24小时

(8) If the moisture absorbent material (silica gel) has faded away or the LEDs have exceeded the storage time, baking treatment should be performed after unpacking and based on the following condition ( $60 \pm 5$ )  $^{\circ}\text{C}$  for above 24 hours. 如果干燥剂或包装失效，或者产品不符合以上有效储存条件，需拆包后进行烘烤，烘烤条件： $60 \pm 5^{\circ}\text{C}$ ，大于 24 小时。

If the package is flatulence or damaged, please notify the sales staff to assist. 如果包装胀气或者破

(9) Similar to most Solid state devices; LEDs are sensitive to Electro-Static Discharge (ESD) and Electrical Over Stress (EOS). 像其他的半导体电子器件一样，LED 对静电过流击穿非常敏感，需要做好防护。

(10) Other points for attention, please refer to our relevant information. 其它注意事项请参照瑞丰相关资料。

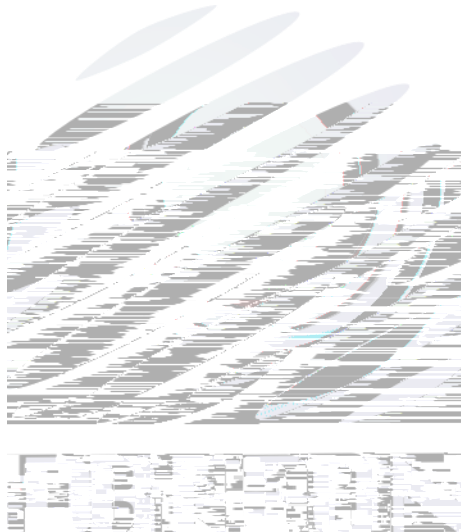





Declare 申明

This specification is written both in English and in Chinese and the latter is formal.

产品规格书以中英文方式书写，若有冲突以中文版本为准。